

CAST IRON SUBMERSIBLE PUMPS

CATALOGUE



CAST IRON SUBMERSIBLE PUMPS
DÖKÜM DALGIÇ POMPA

 **vansan**
WATER TECHNOLOGIES

www.vansan.com.tr





DÖKÜM DALGIÇ POMPA **50 HZ**
CAST IRON SUBMERSIBLE PUMPS

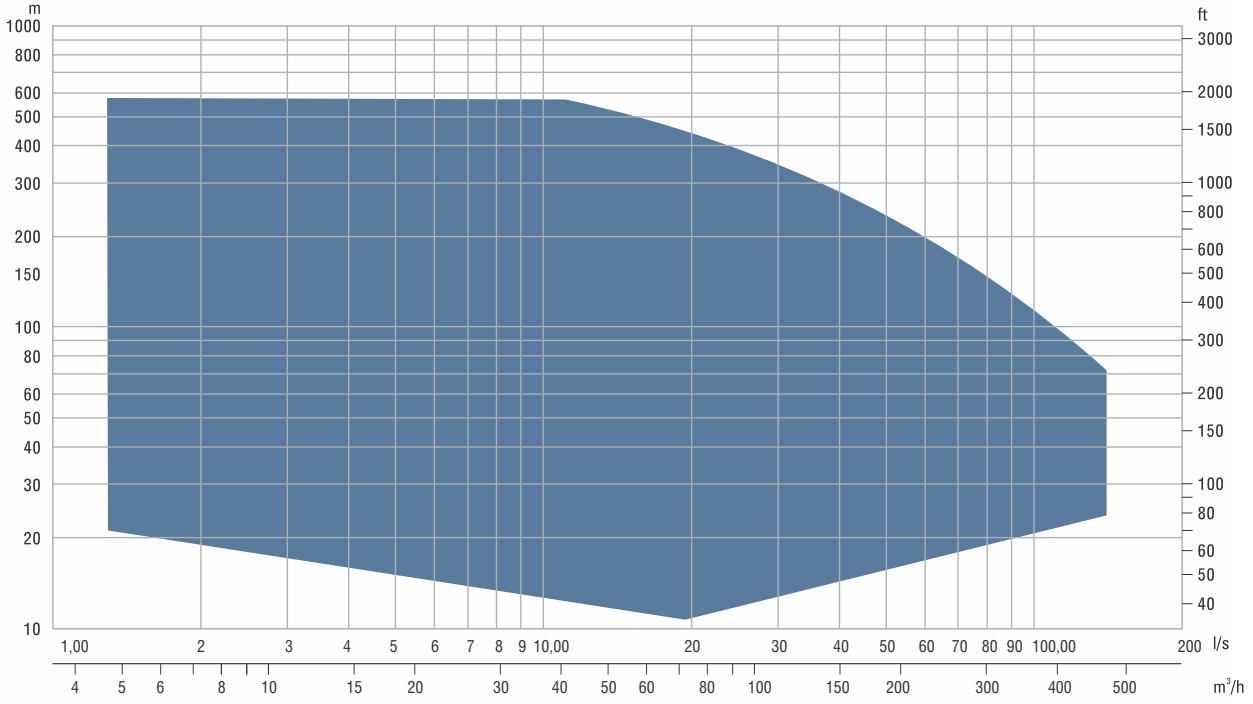

Genel Performans Aralığı

General Performance Range

- Uzun ömür
- Yüksek verim
- Yüksek dayanıklılık ve kolay montaj
- Kolay servis imkanı
- NEMA standartlarında motor bağlantısı
- Aşınmaya dayanıklı su ile yağlamalı yataklar
- Suyun geri kaçmasını engelleyen çekvalf

- Long life
- High efficiency
- High durability and solid construction
- Easy service operation
- Suitable connection in NEMA standards
- Water lubricated rubber bearing
- Built-in checkvalve to prevent back flow

Genel Bilgi

General Information

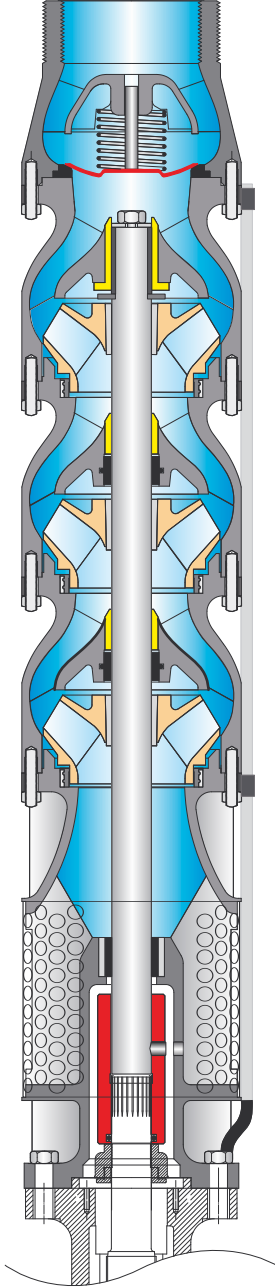

Vansan Dalgıç Pompa'ları sistemde ara pompaj olarak kullanılabilirler. Dalgıç Pompa dik olarak monte edilebileceği gibi yatık da monte edilebilir.

Vansan Submersible Pumps can also be used as booster pumps as shown. Vansan Pumps can also be used horizontally.

Kauçuk malzemeden imal edilen yataklardaki kum kanalları, pompalanan akışkan içerisindeki kum parçalarının yataklara zarar vermeden pompayı terketmelerini sağlar.

Rubber bearings are water lubricated and have sand channels to make enable the sand particles leave the pump with the pumped liquid.

Paslanmaz çelik malzemeden imal edilen süzgeç, belli bir ölçüden büyük parçaların pompanın içine girmesini engeller.

The stainless steel strainer prevents particles over a certain size from entering the pump.

**CAST
IRON
SUBMERSIBLE
PUMPS**



Ürün Kodu Sistemi

Product Code System

VRP CB 0602 / 11



C: cast iron
B: bronz

Part List / Parça Listesi

No	Parça Adı / Part Name	Malzeme / Material
1	Emiş haznesi / Suction case	Pik döküm (GG 20), Sfero döküm (GGG 40), Bronz (ASTM B145) Cast iron (GG 20), Ductile cast iron (GGG 40), Bronz (ASTM B145)
2	Emiş haznesi aşınma bileziği / Suction case wear ring	Bronz (ASTM B145) / Bronze (ASTM B145)
3	Kaplin O-ringi / Coupling o - ring	-
4	Kaplin / Coupling	Paslanmaz çelik (ASTM A582) / Stainless steel (ASTM A582)
5	Kaplin kaması / Coupling Key	Paslanmaz çelik (ASTM A582) / Stainless steel (ASTM A582)
6	Pompa mili / Pump shaft	Paslanmaz çelik (ASTM A582) / Stainless steel (ASTM A582)
7	Burç / Bush	Bronz (ASTM B145) / Bronze (ASTM B145)
8	Difüzör yatağı / Diffuser bed	Bronz (ASTM B145) / Bronze (ASTM B145)
9	Difüzör / Diffuser	Pik döküm (GG 20), Sfero döküm (GGG 40), Bronz (ASTM B145) Cast iron (GG 20), Ductile cast iron (GGG 40), Bronz (ASTM B145)
10	Difüzör O-ringi / Diffuser O-ring	-
11	Çark / Impeller	Pik döküm (GG 20), Sfero döküm (GGG 40), Bronz (ASTM B145) Cast iron (GG 20), Ductile cast iron (GGG 40), Bronz (ASTM B145)
12	Çark tespit burcu / Collet	Paslanmaz çelik (ASTM A582) / Stainless steel (ASTM A582)
13	Klepe lastiği / Diffuser wear ring	-
14	Klepe / Valve	Paslanmaz çelik (ASTM A582) / Stainless steel (ASTM A582)
15	Klepe yayı / Valve spring	-
16	Çıkış haznesi / Discharge case	Pik döküm (GG 20), Sfero döküm (GGG 40), Bronz (ASTM B145) Cast iron (GG 20), Ductile cast iron (GGG 40), Bronz (ASTM B145)
17	Kablo koruma tutturacağı / Cable guard support	Paslanmaz çelik (ASTM A582) / Stainless steel (ASTM A582)
18	Kablo koruma / Cable guard	Paslanmaz çelik (ASTM A582) / Stainless steel (ASTM A582)

Teknik Çizim

Technical Drawing

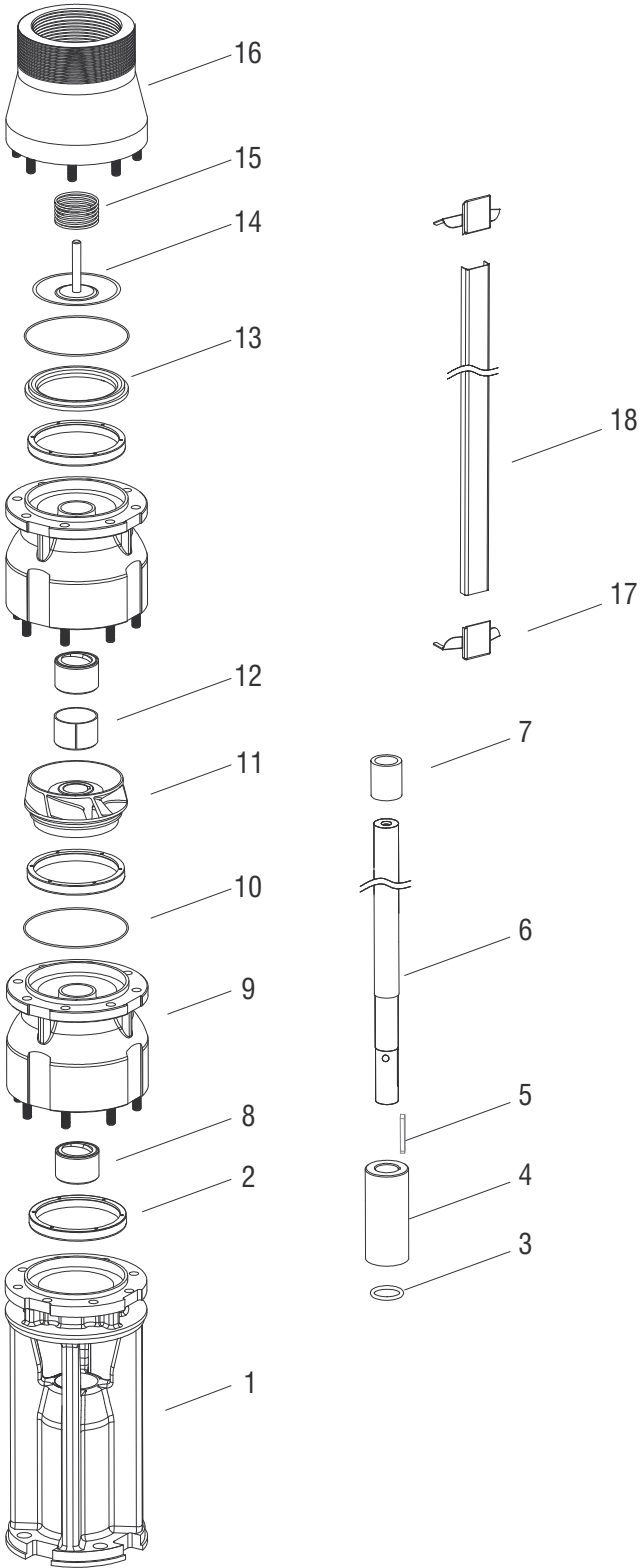

Teknik Özellikler

Technical specifications

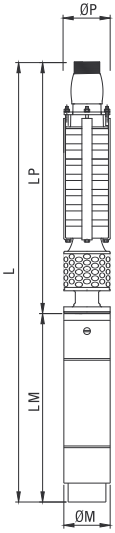

Maks. gerilim değişimi / Voltage
380-415V (+%6-%10)

Frekans / Frequency
50 Hz. / 50 Hz.

Maks. kum miktarı / Max. sand content
50 gr/m³ / 50 gr/m³

Maks. su sıcaklığı / Max. water temp.
30°C (50°C ops.) / 30°C (50°C ops.)

Opsiyonel malzemeler için lütfen irtibata geçiniz.
Please contact us for optional materials.

Ara Çanak / Diffuser

Pik Döküm (GG 20) / Cast Iron (GG 20)
Sfero Döküm (GGG40) / Ductile Iron (GGG40)
Bronz (ASTM B145-4A) / Bronze (ASTM B145-4A)
Paslanmaz Çelik (AISI304, AISI316, duplex) / Stain. Steel (AISI304, AISI316, duplex)

Çark / Impeller

Bronz (ASTM B145-4A) / Bronze (ASTM B145-4A)
Paslanmaz (AISI304, AISI316, duplex) / Stain. Steel (AISI304, AISI316, duplex)

Pompa Mili / Shaft

Paslanmaz Çelik (ASTM A582 type 416-420) / Stain. Steel (ASTM A582 type 416-420)
Paslanmaz Çelik (AISI304, AISI316, duplex) / Stain. Steel (AISI304, AISI316, duplex)

Kaplin / Coupling

Paslanmaz Çelik (ASTM A582 type 416-420) / Stain. Steel (ASTM A582 type 416-420)
Paslanmaz Çelik (AISI304, AISI316, duplex) / Stain. Steel (AISI304, AISI316, duplex)

Çark Tespit Burcu / Collet

Paslanmaz Çelik (ASTM A582 type 416-420) / Stain. Steel (ASTM A582 type 416-420)
Paslanmaz Çelik (AISI304, AISI316, duplex) / Stain. Steel (AISI304, AISI316, duplex)

Süzgeç / Filter

Paslanmaz Çelik (ASTM A582 type 420) / Stain. Steel (ASTM A582 type 420)
Paslanmaz Çelik (AISI304, AISI316) / Stain. Steel (AISI304, AISI316)



Pompa Tipi Pump type	Kad. Sayısı Stages	Motor		Ölçüler / Dimensions (mm)					Ağırlık / Weight (kg)		
		KW	HP	L	LM	LP	ØM	ØP	Motor Motor	Pompa Pump	Toplam Total
VRP 0602/09	9	4	5,5	1504	649	855	142	142	40	45	85
VRP 0602/12	12	5,5	7,5	1668	678	990	142	142	43,5	54	97,5
VRP 0602/17	17	7,5	10	1973	758	1215	142	142	50	69	119
VRP 0602/21	21	9,3	12,5	2195	800	1395	142	142	55	81	136
VRP 0602/25	25	11	15	2426	851	1575	142	142	60	93	153
VRP 0602/29	29	13	17,5	2666	911	1755	142	142	65	105	170
VRP 0602/34	34	15	20	2953	973	1980	142	142	72	120	192

Pompa Tipi Pump type	Kad. Sayısı Stages	Motor		Akım Current (A)	m ³ /h l/s	0	2,50	5	7,50	10	12,50	13	15
		KW	HP			0	0,69	1,39	2,08	2,78	3,47	3,61	4,17
VRP 0602/09	9	4	5,5	10,2	Basma Yüksekliği / Head (m)	116	116	111	101	84	61	56	32
VRP 0602/12	12	5,5	7,5	13,3		155	155	147	134	112	81	74	43
VRP 0602/17	17	7,5	10	17,2		220	219	209	190	159	115	105	61
VRP 0602/21	21	9,3	12,5	20,8		272	271	258	235	196	142	130	75
VRP 0602/25	25	11	15	23,7		323	323	307	280	234	169	155	90
VRP 0602/29	29	13	17,5	28,7		375	374	356	325	271	196	179	104
VRP 0602/34	34	15	20	33,1		440	439	418	381	318	230	210	122

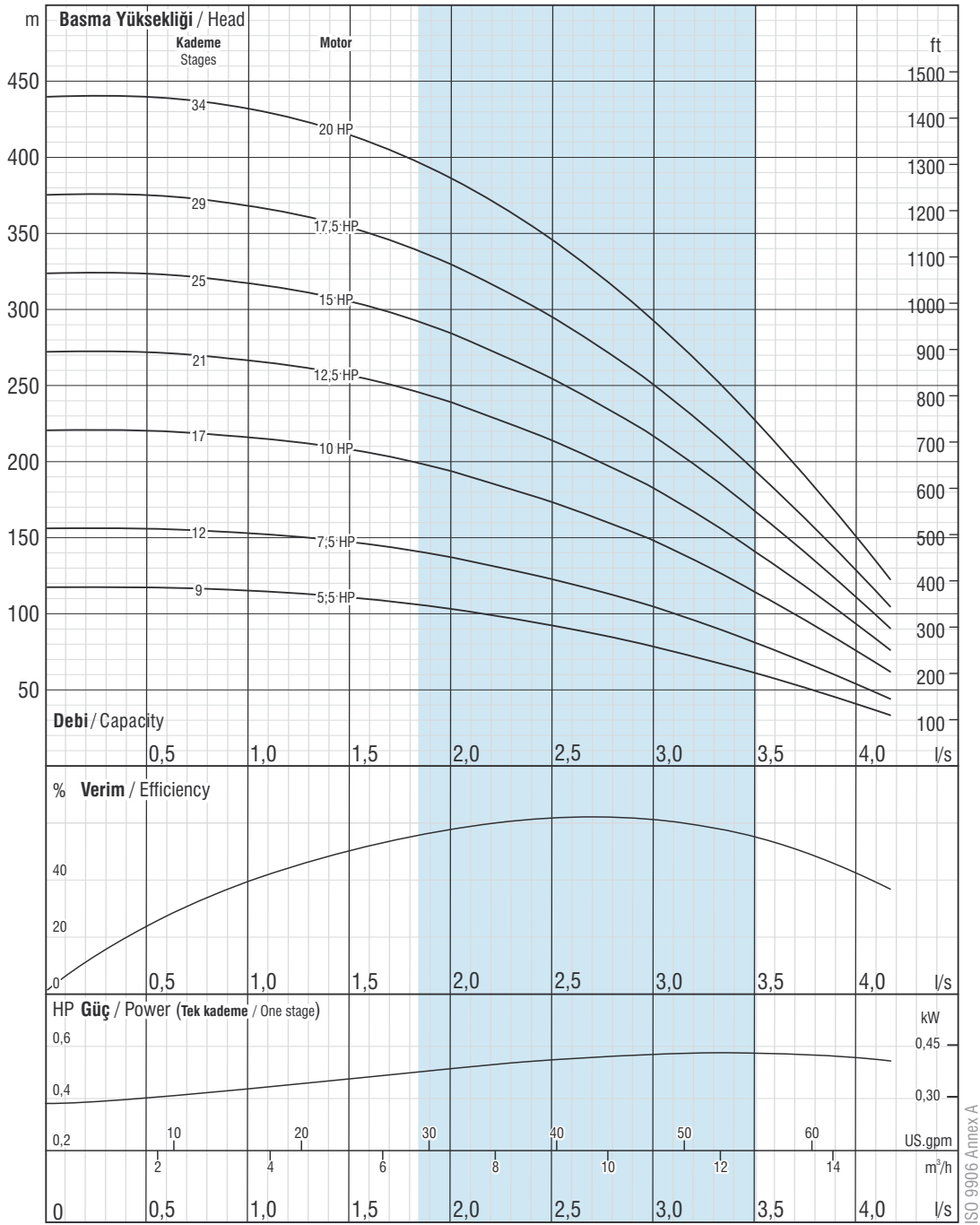

Firmamız teknolojik gelişmeler nedeniyle değişiklik hakkını saklı tutar.

Due to continuous improvement in design we reserve the right to amend specifications or data without prior notice.

VRP 0602

Çark kanat sayısı / No. of vanes
6

Çıkış haznesi bağlantısı / Outlet connection diameter
2" - 2 1/2" (içten pasolu) / 2 1/2" (inside threaded)

Pompa dış çapı / Pump outside diameter
142 mm

Dönüş Yönü / Rotation
Saatin tersi yönünde / CCW

Devir / Revolution
2900 rpm

Mil çapı / Shaft diameter
19 mm

Pompa performans eğrileri 1 bar atmosfer basıncı altında 15 °C sıcaklığındaki, özgül yoğunluğu 1 gr/cm³ olan su ile elde edilmiştir.
The hydraulic working characteristics have been taken with water at 15 °C, at the atmospheric pressure of 1 bar and specific gravity is 1 gr/cm³



Teknik Özellikler

Technical specifications

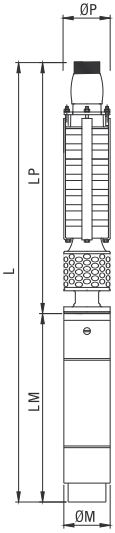

Maks. gerilim değişimi / Voltage
380-415V (+%6-%10)

Frekans / Frequency
50 Hz. / 50 Hz.

Maks. kum miktarı / Max. sand content
50 gr/m³ / 50 gr/m³

Maks. su sıcaklığı / Max. water temp.
30°C (50°C ops.) / 30°C (50°C ops.)

Opsiyonel malzemeler için lütfen irtibata geçiniz.
Please contact us for optional materials.

Ara Çanak / Diffuser

Pik Döküm (GG 20) / Cast Iron (GG 20)
Sfero Döküm (GGG40) / Ductile Iron (GGG40)
Bronz (ASTM B145-4A) / Bronze (ASTM B145-4A)
Paslanmaz Çelik (AISI304, AISI316, duplex) / Stain. Steel (AISI304, AISI316, duplex)

Çark / Impeller

Bronz (ASTM B145-4A) / Bronze (ASTM B145-4A)
Paslanmaz (AISI304, AISI316, duplex) / Stain. Steel (AISI304, AISI316, duplex)

Pompa Mili / Shaft

Paslanmaz Çelik (ASTM A582 type 416-420) / Stain. Steel (ASTM A582 type 416-420)
Paslanmaz Çelik (AISI304, AISI316, duplex) / Stain. Steel (AISI304, AISI316, duplex)

Kaplin / Coupling

Paslanmaz Çelik (ASTM A582 type 416-420) / Stain. Steel (ASTM A582 type 416-420)
Paslanmaz Çelik (AISI304, AISI316, duplex) / Stain. Steel (AISI304, AISI316, duplex)

Çark Tespit Burcu / Collet

Paslanmaz Çelik (ASTM A582 type 416-420) / Stain. Steel (ASTM A582 type 416-420)
Paslanmaz Çelik (AISI304, AISI316, duplex) / Stain. Steel (AISI304, AISI316, duplex)

Süzgeç / Filter

Paslanmaz Çelik (ASTM A582 type 420) / Stain. Steel (ASTM A582 type 420)
Paslanmaz Çelik (AISI304, AISI316) / Stain. Steel (AISI304, AISI316)



TS 11146

Pompa Tipi Pump type	Kad. Sayısı Stages	Motor		Ölçüler / Dimensions (mm)					Ağırlık / Weight (kg)		
		KW	HP	L	LM	LP	ØM	ØP	Motor Motor	Pompa Pump	Toplam Total
VRP 0604/05	5	4	5,5	1324	649	675	142	142	40	33	73
VRP 0604/07	7	5,5	7,5	1443	678	765	142	142	43,5	39	82,5
VRP 0604/09	9	7,5	10	1613	758	855	142	142	50	45	95
VRP 0604/12	12	9,3	12,5	1790	800	990	142	142	55	54	109
VRP 0604/14	14	11	15	1931	851	1080	142	142	60	60	120
VRP 0604/16	16	13	17,5	2081	911	1170	142	142	65	66	131
VRP 0604/19	19	15	20	2278	973	1305	142	142	72	75	147
VRP 0604/24	24	18,5	25	2536	1006	1530	142	142	76	90	166
VRP 0604/28	28	22	30	2816	1106	1710	142	142	87	102	189
VRP 0604/34	34	26,5	35	3197	1217	1980	142	142	98	120	218

Pompa Tipi Pump type	Kad. Sayısı Stages	Motor		Akım Current (A)	m ³ /h l/s	0	5	7,50	10	12,50	15	17,50	20
		KW	HP			0	1,39	2,08	2,78	3,47	4,17	4,86	5,56
VRP 0604/05	5	4	5,5	10,2	Basma Yüksekliği / Head (m)	71	69	67	64	58	49	38	21
VRP 0604/07	7	5,5	7,5	13,3		99	97	94	89	81	69	54	30
VRP 0604/09	9	7,5	10	17,2		128	125	121	115	104	89	69	38
VRP 0604/12	12	9,3	12,5	20,8		170	166	162	153	138	119	92	51
VRP 0604/14	14	11	15	23,7		199	194	189	178	161	138	107	59
VRP 0604/16	16	13	17,5	28,7		227	222	216	204	185	158	122	68
VRP 0604/19	19	15	20	33,1		270	263	256	242	219	188	145	80
VRP 0604/24	24	18,5	25	41,8		341	332	324	305	277	237	183	102
VRP 0604/28	28	22	30	48,5		397	388	378	356	323	277	214	118
VRP 0604/34	34	26,5	35	56,4		483	471	458	433	392	336	260	144

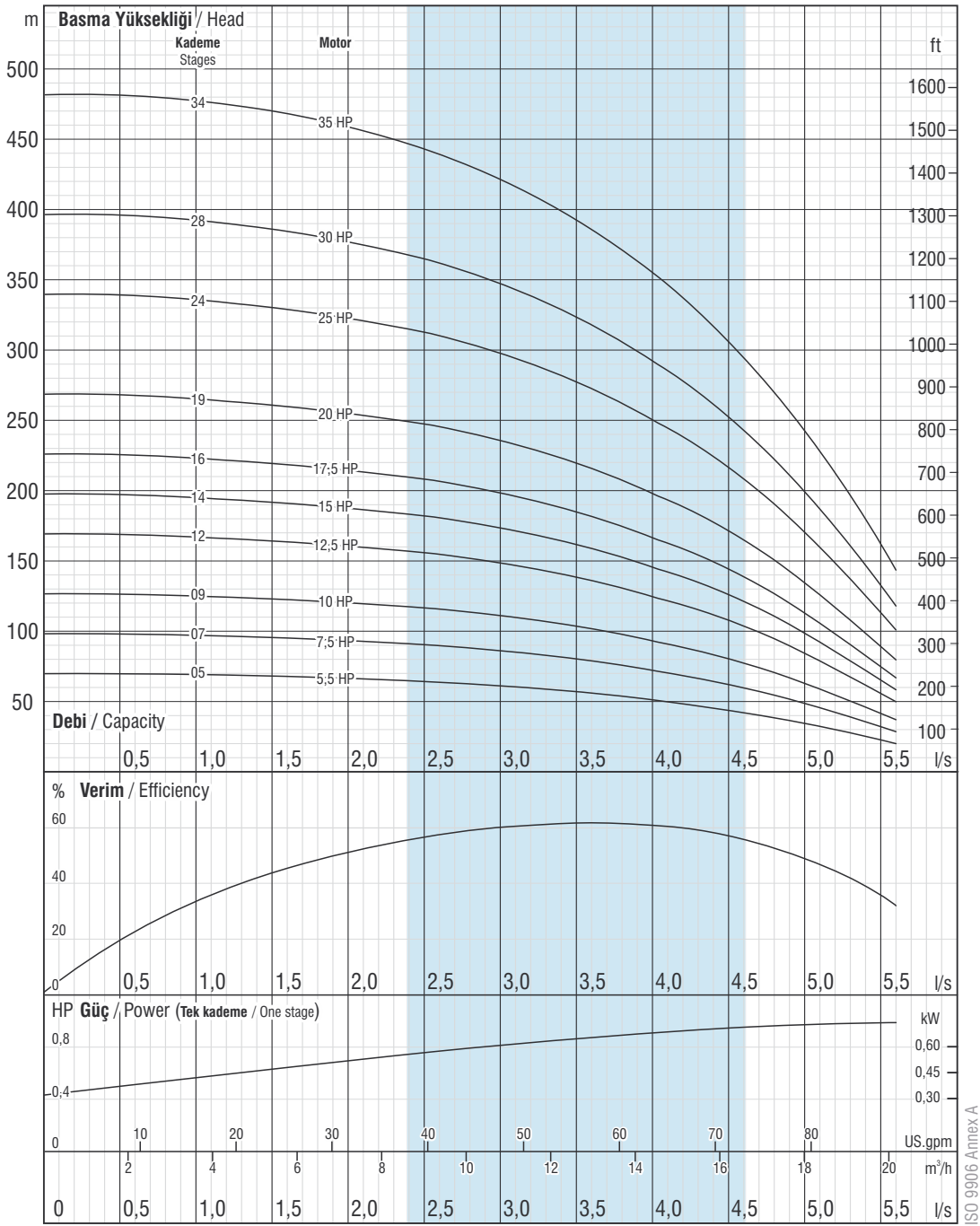

Firmamız teknolojik gelişmeler nedeniyle değişiklik hakkını saklı tutar.

Due to continuous improvement in design we reserve the right to amend specifications or data without prior notice.

VRP 0604

Çark kanat sayısı / No. of vanes
8

Çıkış haznesi bağlantısı / Outlet connection diameter
2 1/2" (içten pasolu) / 2 1/2" (inside threaded)

Pompa dış çapı / Pump outside diameter
142 mm

Dönüş Yönü / Rotation
Saatin tersi yönünde / CCW

Devir / Revolution
2900 rpm

Mil çapı / Shaft diameter
19 mm



Pompa performans eğrileri 1 bar atmosfer basıncı altında 15 °C sıcaklığındaki, özgül yoğunluğu 1 gr/cm³ olan su ile elde edilmiştir.
The hydraulic working characteristics have been taken with water at 15 °C, at the atmospheric pressure of 1 bar and specific gravity is 1 gr/cm³

Teknik Özellikler

Technical specifications

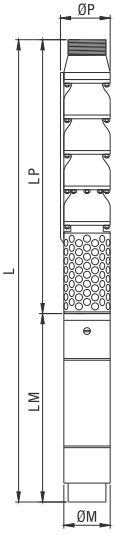

Maks. gerilim değişimi / Voltage
380-415V (+%6-%10)

Frekans / Frequency
50 Hz. / 50 Hz.

Maks. kum miktarı / Max. sand content
50 gr/m³ / 50 gr/m³

Maks. su sıcaklığı / Max. water temp.
30°C (50°C ops.) / 30°C (50°C ops.)

Opsiyonel malzemeler için lütfen irtibata geçiniz.
Please contact us for optional materials.

Ara Çanak / Diffuser

Pik Döküm (GG 20) / Cast Iron (GG 20)
Sfero Döküm (GGG40) / Ductile Iron (GGG40)
Bronz (ASTM B145-4A) / Bronze (ASTM B145-4A)
Paslanmaz Çelik (AISI304, AISI316, duplex) / Stain. Steel (AISI304, AISI316, duplex)

Çark / Impeller

Pik Döküm (GG 20) / Cast Iron (GG 20)
Sfero Döküm (GGG40) / Ductile Iron (GGG40)
Bronz (ASTM B145-4A) / Bronze (ASTM B145-4A)
Paslanmaz (AISI304, AISI316, duplex) / Stain. Steel (AISI304, AISI316, duplex)

Pompa Mili / Shaft

Paslanmaz Çelik (ASTM A582 type 416-420) / Stain. Steel (ASTM A582 type 416-420)
Paslanmaz Çelik (AISI304, AISI316, duplex) / Stain. Steel (AISI304, AISI316, duplex)

Kaplin / Coupling

Paslanmaz Çelik (ASTM A582 type 416-420) / Stain. Steel (ASTM A582 type 416-420)
Paslanmaz Çelik (AISI304, AISI316, duplex) / Stain. Steel (AISI304, AISI316, duplex)

Çark Tespit Burcu / Collet

Paslanmaz Çelik (ASTM A582 type 416-420) / Stain. Steel (ASTM A582 type 416-420)
Paslanmaz Çelik (AISI304, AISI316, duplex) / Stain. Steel (AISI304, AISI316, duplex)

Süzgeç / Filter

Paslanmaz Çelik (ASTM A582 type 420) / Stain. Steel (ASTM A582 type 420)
Paslanmaz Çelik (AISI304, AISI316) / Stain. Steel (AISI304, AISI316)



TS 11146

Pompa Tipi Pump type	Kad. Sayısı Stages	Motor		Ölçüler / Dimensions (mm)					Ağırlık / Weight (kg)		
		KW	HP	L	LM	LP	ØM	ØP	Motor Motor	Pompa Pump	Toplam Total
VSP 0631/02	2	4	5,5	1285	649	636	142	142	40	26	66
VSP 0631/03	3	5,5	7,5	1439	678	761	142	142	44	32	76
VSP 0631/05	5	7,5	10	1769	758	1011	142	142	50	45	95
VSP 0631/06	6	9,3	12,5	1936	800	1136	142	142	55	52	107
VSP 0631/07	7	11	15	2112	851	1261	142	142	60	58	118
VSP 0631/08	8	13	17,5	2297	911	1386	142	142	65	65	130
VSP 0631/10	10	15	20	2609	973	1636	142	142	72	78	150
VSP 0631/12	12	18,5	25	2892	1006	1886	142	142	76	91	167
VSP 0631/15	15	22	30	3367	1106	2261	142	142	87	110	197
VSP 0631/18	18	26,5	35	3853	1217	2636	142	142	98	130	228
VSP 0631/20	20	30	40	4133	1247	2886	142	142	103	143	246
VSP 0631/25	25	37	50	4858	1347	3511	142	142	110	175	285

Pompa Tipi Pump type	Kad. Sayısı Stages	Motor		Akım Current (A)	m ³ /h l/s	0	20	30	40	45	50	55	60
		KW	HP			0	5,56	8,33	11,11	12,50	13,89	15,28	16,67
VSP 0631/02	2	4	5,5	10,2	Basma Yüksekliği / Head (m)	31	26	23	19	17	14	12	9
VSP 0631/03	3	5,5	7,5	13,3		46	39	34	29	25	22	18	13
VSP 0631/05	5	7,5	10	17,2		76	65	57	48	42	36	29	22
VSP 0631/06	6	9,3	12,5	20,8		92	78	68	57	51	43	35	26
VSP 0631/07	7	11	15	23,7		107	90	80	67	59	51	41	30
VSP 0631/08	8	13	17,5	28,7		122	103	91	76	68	58	47	35
VSP 0631/10	10	15	20	33,1		153	129	114	95	84	72	59	43
VSP 0631/12	12	18,5	25	41,8		184	155	137	114	101	87	70	52
VSP 0631/15	15	22	30	48,5		229	194	171	143	127	108	88	65
VSP 0631/18	18	26,5	35	56,4		275	233	205	172	152	130	106	78
VSP 0631/20	20	30	40	64,6		306	258	228	191	169	145	117	87
VSP 0631/25	25	37	50	79,7		382	323	285	239	211	181	147	109

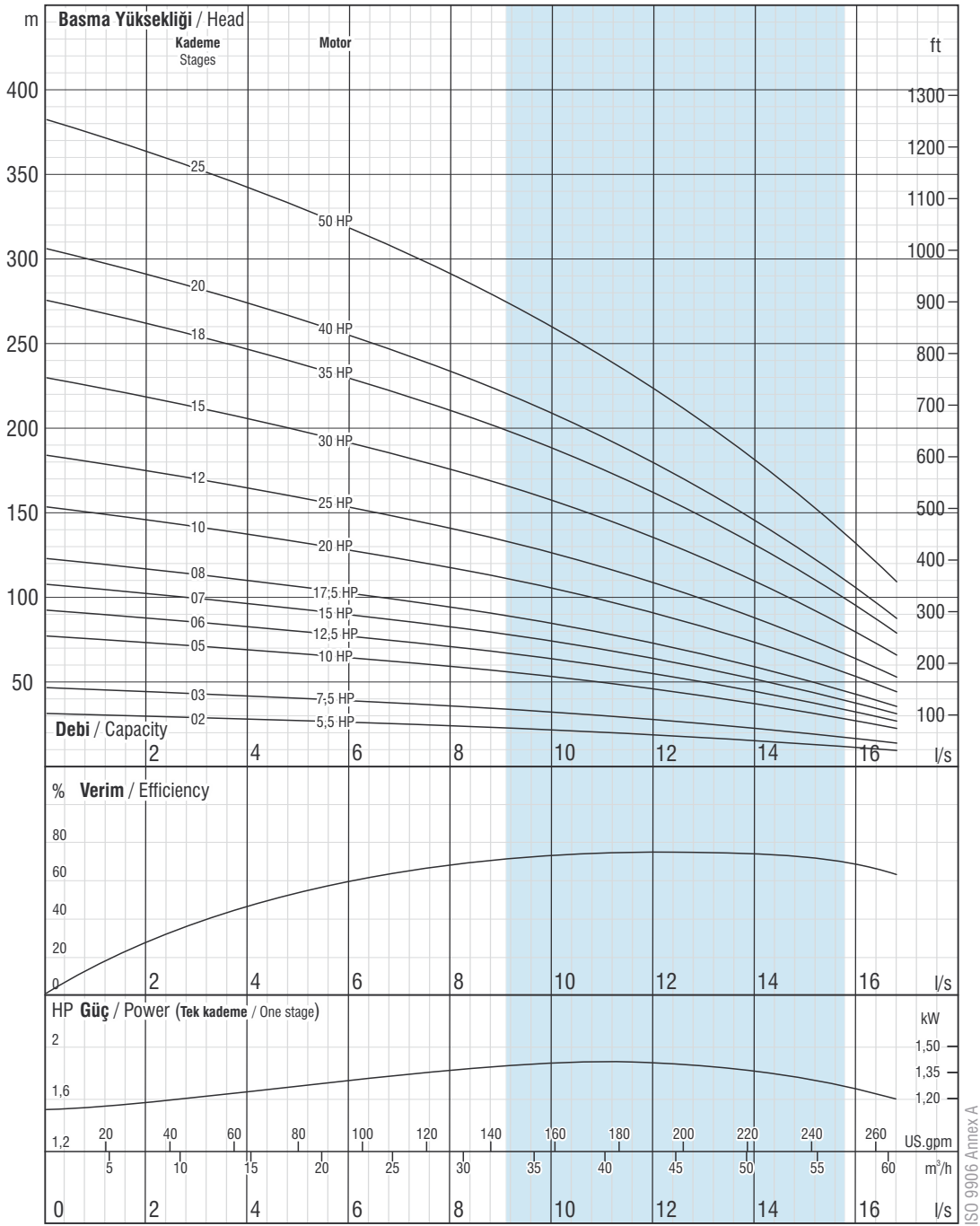

Firmamız teknolojik gelişmeler nedeniyle değişiklik hakkını saklı tutar.

Due to continuous improvement in design we reserve the right to amend specifications or data without prior notice.

VSP 0631

Çark kanat sayısı / No. of vanes
5

Çıkış haznesi bağlantısı / Outlet connection diameter
2 1/2" (içten pasolu) / 2 1/2" (inside threaded)

Pompa dış çapı / Pump outside diameter
147 mm

Dönüş Yönü / Rotation
Saatin tersi yönünde / CCW

Devir / Revolution
2900 rpm

Mil çapı / Shaft diameter
25,4 mm

Pompa performans eğrileri 1 bar atmosfer basıncı altında 15 °C sıcaklığındaki, özgül yoğunluğu 1 gr/cm³ olan su ile elde edilmiştir.
The hydraulic working characteristics have been taken with water at 15 °C, at the atmospheric pressure of 1 bar and specific gravity is 1 gr/cm³



Teknik Özellikler

Technical specifications

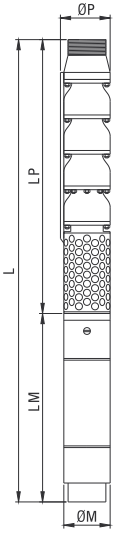

Maks. gerilim değişimi / Voltage
380-415V (+%6-%10)

Frekans / Frequency
50 Hz. / 50 Hz.

Maks. kum miktarı / Max. sand content
50 gr/m³ / 50 gr/m³

Maks. su sıcaklığı / Max. water temp.
30°C (50°C ops.) / 30°C (50°C ops.)

Opsiyonel malzemeler için lütfen irtibata geçiniz.
Please contact us for optional materials.

Ara Çanak / Diffuser

Pik Döküm (GG 20) / Cast Iron (GG 20)
Sfero Döküm (GGG40) / Ductile Iron (GGG40)
Bronz (ASTM B145-4A) / Bronze (ASTM B145-4A)
Paslanmaz Çelik (AISI304, AISI316, duplex) / Stain. Steel (AISI304, AISI316, duplex)

Çark / Impeller

Pik Döküm (GG 20) / Cast Iron (GG 20)
Sfero Döküm (GGG40) / Ductile Iron (GGG40)
Bronz (ASTM B145-4A) / Bronze (ASTM B145-4A)
Paslanmaz (AISI304, AISI316, duplex) / Stain. Steel (AISI304, AISI316, duplex)

Pompa Mili / Shaft

Paslanmaz Çelik (ASTM A582 type 416-420) / Stain. Steel (ASTM A582 type 416-420)
Paslanmaz Çelik (AISI304, AISI316, duplex) / Stain. Steel (AISI304, AISI316, duplex)

Kaplin / Coupling

Paslanmaz Çelik (ASTM A582 type 416-420) / Stain. Steel (ASTM A582 type 416-420)
Paslanmaz Çelik (AISI304, AISI316, duplex) / Stain. Steel (AISI304, AISI316, duplex)

Çark Tespit Burcu / Collet

Paslanmaz Çelik (ASTM A582 type 416-420) / Stain. Steel (ASTM A582 type 416-420)
Paslanmaz Çelik (AISI304, AISI316, duplex) / Stain. Steel (AISI304, AISI316, duplex)

Süzgeç / Filter

Paslanmaz Çelik (ASTM A582 type 420) / Stain. Steel (ASTM A582 type 420)
Paslanmaz Çelik (AISI304, AISI316) / Stain. Steel (AISI304, AISI316)



TS 11146

Pompa Tipi Pump type	Kad. Sayısı Stages	Motor		Ölçüler / Dimensions (mm)					Ağırlık / Weight (kg)		
		KW	HP	L	LM	LP	ØM	ØP	Motor Motor	Pompa Pump	Toplam Total
VSP 0633/02	2	4	5,5	1285	649	636	142	147	40	26	66
VSP 0633/03	3	5,5	7,5	1439	678	761	142	147	44	32	76
VSP 0633/04	4	7,5	10	1644	758	886	142	147	50	39	89
VSP 0633/05	5	9,3	12,5	1811	800	1011	142	147	55	45	100
VSP 0633/06	6	11	15	1987	851	1136	142	147	60	52	112
VSP 0633/07	7	13	17,5	2172	911	1261	142	147	65	58	123
VSP 0633/08	8	15	20	2359	973	1386	142	147	72	65	137
VSP 0633/11	11	18,5	25	2767	1006	1761	142	147	76	84	160
VSP 0633/13	13	22	30	3117	1106	2011	142	147	87	97	184
VSP 0633/15	15	26,5	35	3478	1217	2261	142	147	98	110	208
VSP 0633/17	17	30	40	3758	1247	2511	142	147	103	123	226
VSP 0633/22	22	37	50	4483	1347	3136	142	147	110	156	266

Pompa Tipi Pump type	Kad. Sayısı Stages	Motor		Akım Current (A)	m ³ /h l/s	0	20	30	40	45	50	55	60
		KW	HP			0	5,56	8,33	11,11	12,50	13,89	15,28	16,67
VSP 0633/02	2	4	5,5	10,2	Basma Yüksekliği / Head (m)	30	28	25	21	19	17	15	13
VSP 0633/03	3	5,5	7,5	13,3		45	42	37	32	29	26	23	19
VSP 0633/04	4	7,5	10	17,2		60	55	50	43	39	35	30	25
VSP 0633/05	5	9,3	12,5	20,8		75	69	62	53	49	43	38	32
VSP 0633/06	6	11	15	23,7		90	83	74	64	58	52	45	38
VSP 0633/07	7	13	17,5	28,7		105	97	87	75	68	61	53	44
VSP 0633/08	8	15	20	33,1		120	111	99	85	78	69	61	51
VSP 0633/11	11	18,5	25	41,8		165	152	137	117	107	96	83	70
VSP 0633/13	13	22	30	48,5		195	180	161	139	126	113	98	83
VSP 0633/15	15	26,5	35	56,4		225	208	186	160	146	130	114	95
VSP 0633/17	17	30	40	64,6		255	235	211	182	165	148	129	108
VSP 0633/22	22	37	50	79,7		330	305	273	235	214	191	167	140

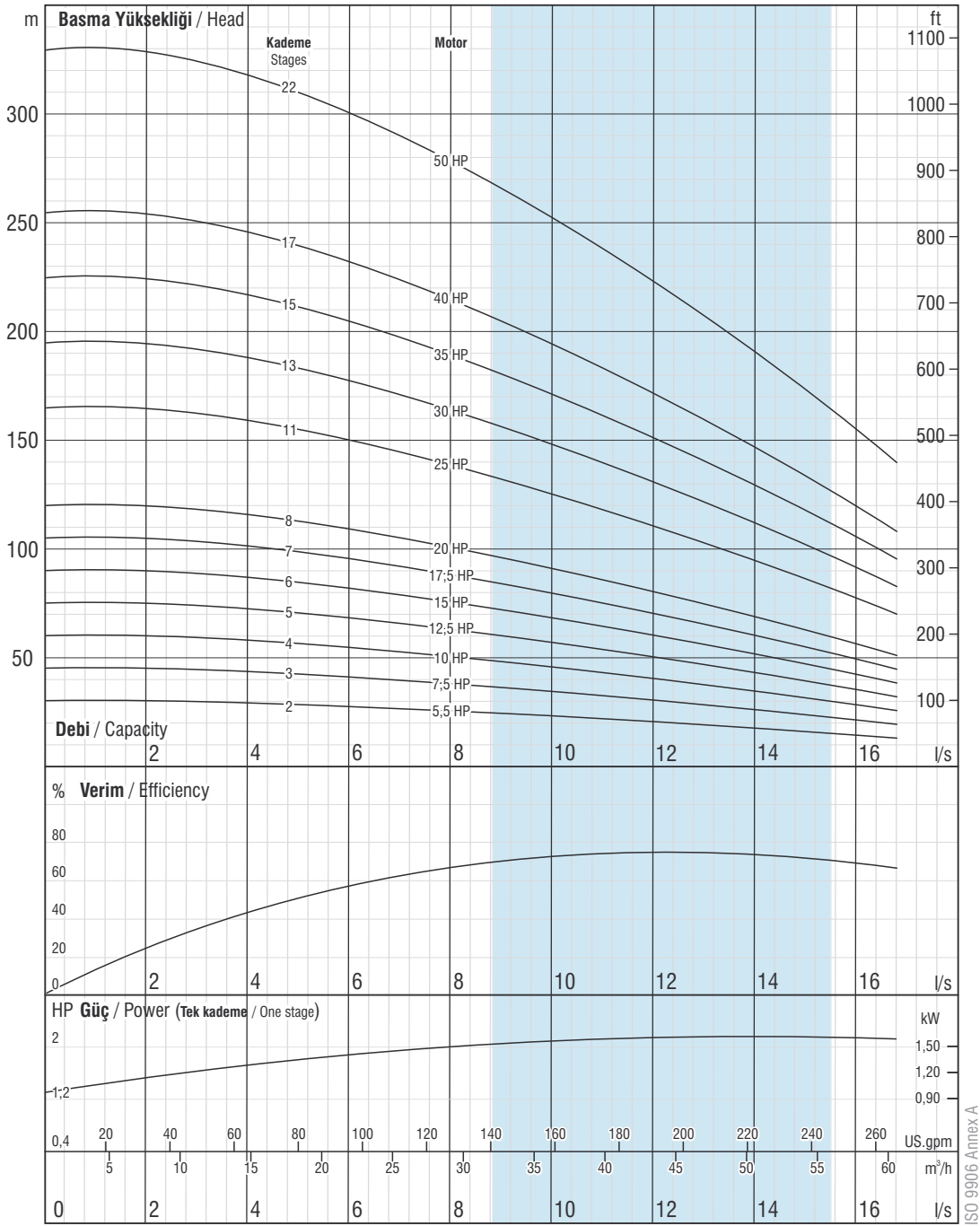

Firmamız teknolojik gelişmeler nedeniyle değişiklik hakkını saklı tutar.

Due to continuous improvement in design we reserve the right to amend specifications or data without prior notice.

VSP 0633

Çark kanat sayısı / No. of vanes
5

Çıkış haznesi bağlantısı / Outlet connection diameter
3" - 4" (içten ve dıştan pasolu)
3" - 4" (inside and outside threaded)

Pompa dış çapı / Pump outside diameter
147 mm

Dönüş Yönü / Rotation
Saatin tersi yönünde / CCW

Devir / Revolution
2900 rpm

Mil çapı / Shaft diameter
25,4 mm

Pompa performans eğrileri 1 bar atmosfer basıncı altında 15 °C sıcaklığındaki, özgül yoğunluğu 1 gr/cm³ olan su ile elde edilmiştir.
The hydraulic working characteristics have been taken with water at 15 °C, at the atmospheric pressure of 1 bar and specific gravity is 1 gr/cm³



Teknik Özellikler

Technical specifications

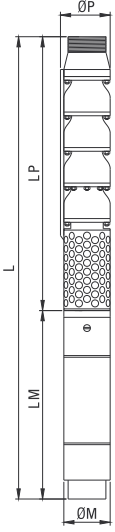

Maks. gerilim değişimi / Voltage
380-415V (+%6-%10)

Frekans / Frequency
50 Hz. / 50 Hz.

Maks. kum miktarı / Max. sand content
50 gr/m³ / 50 gr/m³

Maks. su sıcaklığı / Max. water temp.
30°C (50°C ops.) / 30°C (50°C ops.)

Opsiyonel malzemeler için lütfen irtibata geçiniz.
Please contact us for optional materials.

Ara Çanak / Diffuser

Pik Döküm (GG 20) / Cast Iron (GG 20)
Sfero Döküm (GGG40) / Ductile Iron (GGG40)
Bronz (ASTM B145-4A) / Bronze (ASTM B145-4A)
Paslanmaz Çelik (AISI304, AISI316, duplex) / Stain. Steel (AISI304, AISI316, duplex)

Çark / Impeller

Pik Döküm (GG 20) / Cast Iron (GG 20)
Sfero Döküm (GGG40) / Ductile Iron (GGG40)
Bronz (ASTM B145-4A) / Bronze (ASTM B145-4A)
Paslanmaz (AISI304, AISI316, duplex) / Stain. Steel (AISI304, AISI316, duplex)

Pompa Mili / Shaft

Paslanmaz Çelik (ASTM A582 type 416-420) / Stain. Steel (ASTM A582 type 416-420)
Paslanmaz Çelik (AISI304, AISI316, duplex) / Stain. Steel (AISI304, AISI316, duplex)

Kaplin / Coupling

Paslanmaz Çelik (ASTM A582 type 416-420) / Stain. Steel (ASTM A582 type 416-420)
Paslanmaz Çelik (AISI304, AISI316, duplex) / Stain. Steel (AISI304, AISI316, duplex)

Çark Tespit Burcu / Collet

Paslanmaz Çelik (ASTM A582 type 416-420) / Stain. Steel (ASTM A582 type 416-420)
Paslanmaz Çelik (AISI304, AISI316, duplex) / Stain. Steel (AISI304, AISI316, duplex)

Süzgeç / Filter

Paslanmaz Çelik (ASTM A582 type 420) / Stain. Steel (ASTM A582 type 420)
Paslanmaz Çelik (AISI304, AISI316) / Stain. Steel (AISI304, AISI316)



TS 11146

Pompa Tipi Pump type	Kad. Sayısı Stages	Motor		Ölçüler / Dimensions (mm)					Ağırlık / Weight (kg)		
		KW	HP	L	LM	LP	ØM	ØP	Motor Motor	Pompa Pump	Toplam Total
VSP 0634/01	1	4	5,5	1160	649	511	142	147	40	19	59
VSP 0634/02	2	5,5	7,5	1314	678	636	142	147	44	26	69
VSP 0634/03	3	7,5	10	1519	758	761	142	147	50	32	82
VSP 0634/04	4	9,3	12,5	1686	800	886	142	147	55	39	94
VSP 0634/05	5	11	15	1862	851	1011	142	147	60	45	105
VSP 0634/06	6	13	17,5	2047	911	1136	142	147	65	52	117
VSP 0634/07	7	15	20	2234	973	1261	142	147	72	58	130
VSP 0634/08	8	18,5	25	2392	1006	1386	142	147	76	65	141
VSP 0634/10	10	22	30	2742	1106	1636	142	147	87	78	165
VSP 0634/12	12	26,5	35	3103	1217	1886	142	147	98	91	189
VSP 0634/14	14	30	40	3383	1247	2136	142	147	103	104	207
VSP 0634/17	17	37	50	3858	1347	2511	142	147	110	123	233

Pompa Tipi Pump type	Kad. Sayısı Stages	Motor		Akım Current (A)	m ³ /h l/s	0	20	30	40	50	55	60	75
		KW	HP			0	5,56	8,33	11,11	13,89	15,28	16,67	20,83
VSP 0634/01	1	4	5,5	10,2	Basma Yüksekliği / Head (m)	14	13	13	12	10	10	9	6
VSP 0634/02	2	5,5	7,5	13,3		28	26	25	23	21	19	18	12
VSP 0634/03	3	7,5	10	17,2		42	40	38	35	31	29	27	19
VSP 0634/04	4	9,3	12,5	20,8		56	53	50	47	42	39	36	25
VSP 0634/05	5	11	15	23,7		70	66	63	58	52	49	45	31
VSP 0634/06	6	13	17,5	28,7		84	79	75	70	63	58	54	37
VSP 0634/07	7	15	20	33,1		98	92	88	82	73	68	63	43
VSP 0634/08	8	18,5	25	41,8		112	106	100	93	84	78	71	49
VSP 0634/10	10	22	30	48,5		140	132	126	117	104	97	89	62
VSP 0634/12	12	26,5	35	56,4		167	158	151	140	125	117	107	74
VSP 0634/14	14	30	40	64,6		195	185	176	163	146	136	125	87
VSP 0634/17	17	37	50	79,7		237	224	214	198	178	165	152	105

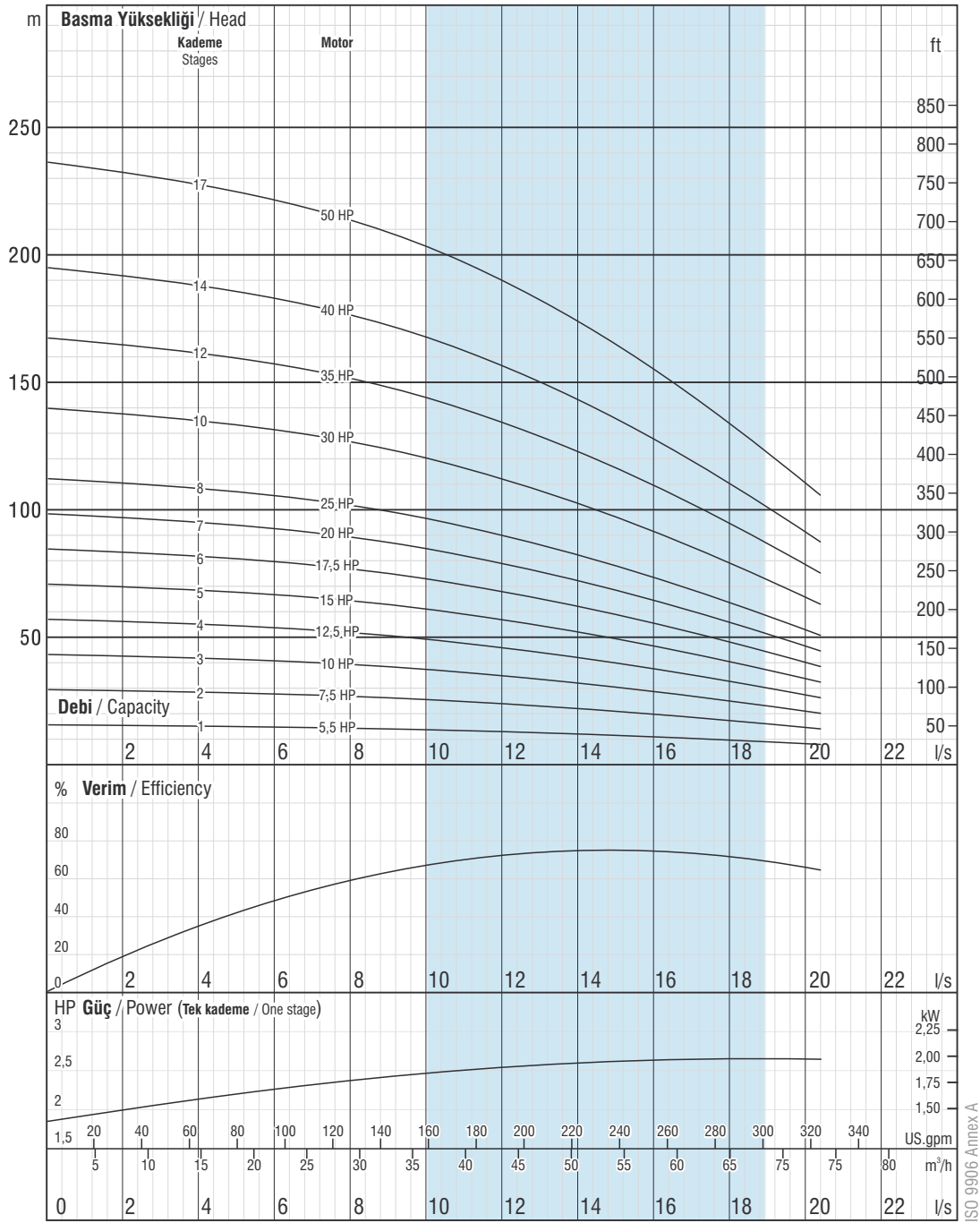

Teknik Özellikler

Technical specifications

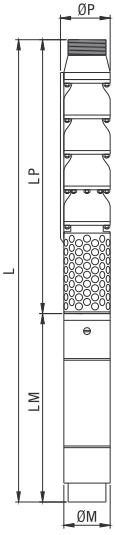

Maks. gerilim değişimi / Voltage
380-415V (+%6-%10)

Frekans / Frequency
50 Hz. / 50 Hz.

Maks. kum miktarı / Max. sand content
50 gr/m³ / 50 gr/m³

Maks. su sıcaklığı / Max. water temp.
30°C (50°C ops.) / 30°C (50°C ops.)

Opsiyonel malzemeler için lütfen irtibata geçiniz.
Please contact us for optional materials.

Ara Çanak / Diffuser

Pik Döküm (GG 20) / Cast Iron (GG 20)
Sfero Döküm (GGG40) / Ductile Iron (GGG40)
Bronz (ASTM B145-4A) / Bronze (ASTM B145-4A)
Paslanmaz Çelik (AISI304, AISI316, duplex) / Stain. Steel (AISI304, AISI316, duplex)

Çark / Impeller

Pik Döküm (GG 20) / Cast Iron (GG 20)
Sfero Döküm (GGG40) / Ductile Iron (GGG40)
Bronz (ASTM B145-4A) / Bronze (ASTM B145-4A)
Paslanmaz (AISI304, AISI316, duplex) / Stain. Steel (AISI304, AISI316, duplex)

Pompa Mili / Shaft

Paslanmaz Çelik (ASTM A582 type 416-420) / Stain. Steel (ASTM A582 type 416-420)
Paslanmaz Çelik (AISI304, AISI316, duplex) / Stain. Steel (AISI304, AISI316, duplex)

Kaplin / Coupling

Paslanmaz Çelik (ASTM A582 type 416-420) / Stain. Steel (ASTM A582 type 416-420)
Paslanmaz Çelik (AISI304, AISI316, duplex) / Stain. Steel (AISI304, AISI316, duplex)

Çark Tespit Burcu / Collet

Paslanmaz Çelik (ASTM A582 type 416-420) / Stain. Steel (ASTM A582 type 416-420)
Paslanmaz Çelik (AISI304, AISI316, duplex) / Stain. Steel (AISI304, AISI316, duplex)

Süzgeç / Filter

Paslanmaz Çelik (ASTM A582 type 420) / Stain. Steel (ASTM A582 type 420)
Paslanmaz Çelik (AISI304, AISI316) / Stain. Steel (AISI304, AISI316)



TS 11146

Pompa Tipi Pump type	Kad. Sayısı Stages	Motor		Ölçüler / Dimensions (mm)					Ağırlık / Weight (kg)		
		KW	HP	L	LM	LP	ØM	ØP	Motor Motor	Pompa Pump	Toplam Total
VSP 073/01	1	5,5	7,5	1281	678	603	142	175	44	19	63
VSP 073/02C	2	9,3	12,5	1528	800	728	142	175	55	30	85
VSP 073/02	2	11	15	1579	851	728	142	175	60	30	90
VSP 073/03B	3	15	20	1826	973	853	142	175	72	41	113
VSP 073/03	3	18,5	25	1859	1006	853	142	175	76	41	117
VSP 073/04	4	22	30	2084	1106	978	142	175	87	52	139
VSP 073/05B	5	26,5	35	2320	1217	1103	142	175	98	63	161
VSP 073/05	5	30	40	2350	1247	1103	142	175	103	63	166
VSP 073/06	6	37	50	2344	1116	1228	192	175	138	74	212
VSP 073/08	8	45	60	2679	1201	1478	192	175	152	96	248
VSP 073/09	9	52	70	2889	1286	1603	192	175	170	107	277
VSP 073/10	10	55	75	3014	1286	1728	192	175	170	118	288
VSP 073/11	11	67	90	3219	1366	1853	192	175	186	129	315
VSP 073/13	13	75	100	3494	1391	2103	192	175	195	151	346

Pompa Tipi Pump type	Kad. Sayısı Stages	Motor		Akım Current (A)	m ³ /h l/s	0	40	60	70	80	90	100	110
		KW	HP			0	11,11	16,67	19,44	22,22	25,00	27,78	30,56
VSP 073/01	1	5,5	7,5	13,3	Basma Yüksekliği / Head (m)	22	21	19	18	17	15	13	11
VSP 073/02C	2	9,3	12,5	20,8		38	35	32	30	27	24	20	15
VSP 073/02	2	11	15	23,7		44	41	38	36	33	30	26	21
VSP 073/03B	3	15	20	33,1		59	55	51	48	44	40	34	27
VSP 073/03	3	18,5	25	41,8		66	62	58	54	50	45	39	32
VSP 073/04	4	22	30	48,5		88	83	77	72	67	60	52	42
VSP 073/05B	5	26,5	35	56,4		99	92	85	80	74	66	56	45
VSP 073/05	5	30	40	64,6		110	103	96	91	84	75	65	53
VSP 073/06	6	37	50	74,3		132	124	115	109	100	90	78	63
VSP 073/08	8	45	60	90,4		176	165	154	145	134	120	104	84
VSP 073/09	9	52	70	103,3		198	186	173	163	151	135	117	95
VSP 073/10	10	55	75	110,5		220	207	192	181	167	151	130	106
VSP 073/11	11	67	90	134,6		242	227	211	199	184	166	143	116
VSP 073/13	13	75	100	150,7	286	269	250	235	218	196	169	137	

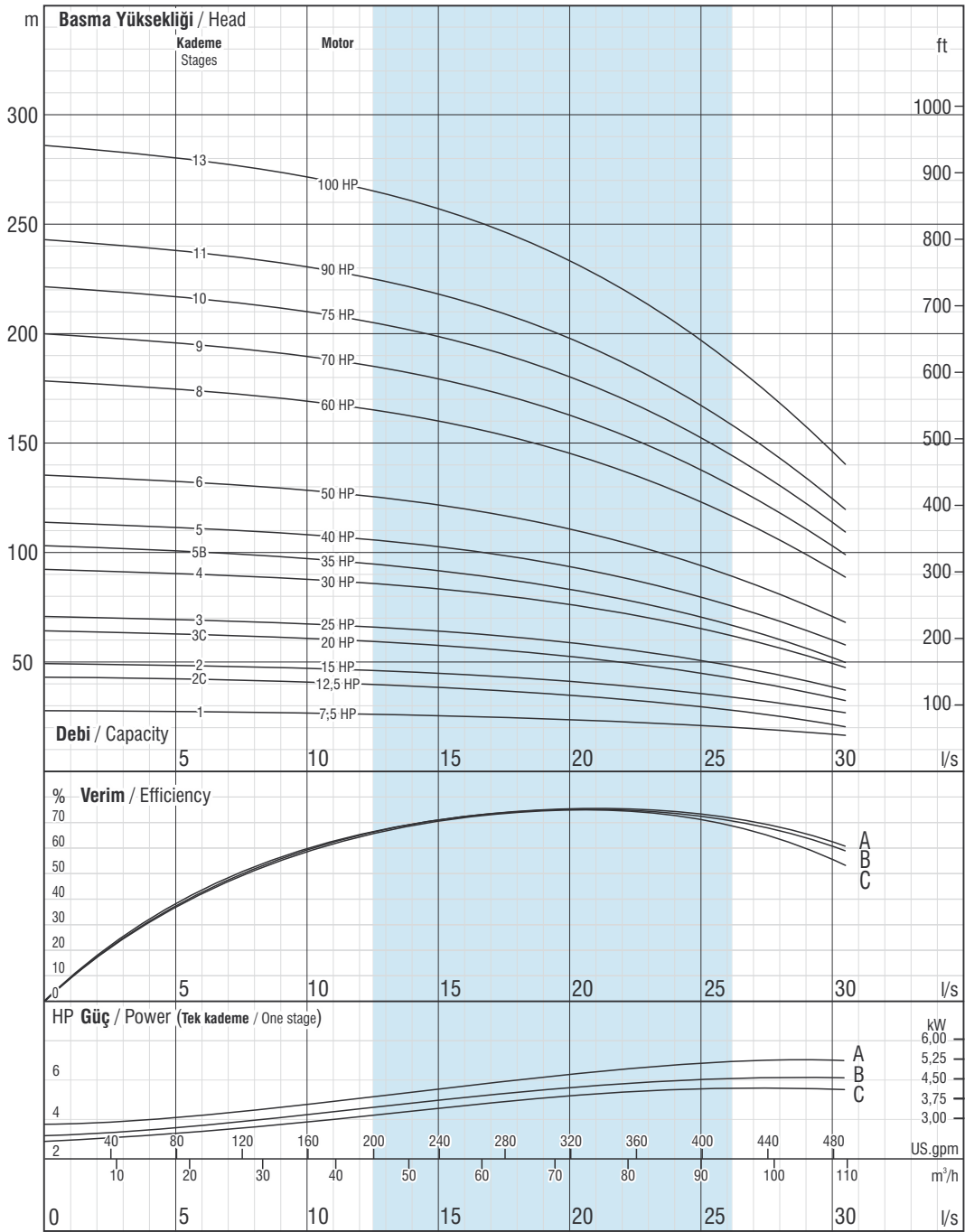

Firmamız teknolojik gelişmeler nedeniyle değişiklik hakkını saklı tutar.

Due to continuous improvement in design we reserve the right to amend specifications or data without prior notice.

VSP 073

Çark kanat sayısı / No. of vanes
6

Çıkış haznesi bağlantısı / Outlet connection diameter
4" - 5" (içten ve dıştan pasolu)
4" - 5" (inside and outside threaded)

Pompa dış çapı / Pump outside diameter
175 mm

Dönüş Yönü / Rotation
Saatın tersi yönünde / CCW

Devir / Revolution
2900 rpm

Mil çapı / Shaft diameter
25,4 mm



Pompa performans eğrileri 1 bar atmosfer basıncı altında 15 °C sıcaklığındaki, özgül yoğunluğu 1 gr/cm³ olan su ile elde edilmiştir.
The hydraulic working characteristics have been taken with water at 15 °C, at the atmospheric pressure of 1 bar and specific gravity is 1 gr/cm³

Teknik Özellikler

Technical specifications

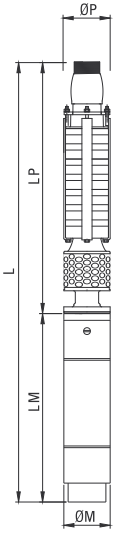

Maks. gerilim değişimi / Voltage
380-415V (+%6-%10)

Frekans / Frequency
50 Hz. / 50 Hz.

Maks. kum miktarı / Max. sand content
50 gr/m³ / 50 gr/m³

Maks. su sıcaklığı / Max. water temp.
30°C (50°C ops.) / 30°C (50°C ops.)

Opsiyonel malzemeler için lütfen irtibata geçiniz.
Please contact us for optional materials.

Ara Çanak / Diffuser

Pik Döküm (GG 20) / Cast Iron (GG 20)
Sfero Döküm (GGG40) / Ductile Iron (GGG40)
Bronz (ASTM B145-4A) / Bronze (ASTM B145-4A)
Paslanmaz Çelik (AISI304, AISI316, duplex) / Stain. Steel (AISI304, AISI316, duplex)

Çark / Impeller

Bronz (ASTM B145-4A) / Bronze (ASTM B145-4A)
Paslanmaz (AISI304, AISI316, duplex) / Stain. Steel (AISI304, AISI316, duplex)

Pompa Mili / Shaft

Paslanmaz Çelik (ASTM A582 type 416-420) / Stain. Steel (ASTM A582 type 416-420)
Paslanmaz Çelik (AISI304, AISI316, duplex) / Stain. Steel (AISI304, AISI316, duplex)

Kaplin / Coupling

Paslanmaz Çelik (ASTM A582 type 416-420) / Stain. Steel (ASTM A582 type 416-420)
Paslanmaz Çelik (AISI304, AISI316, duplex) / Stain. Steel (AISI304, AISI316, duplex)

Çark Tespit Burcu / Collet

Paslanmaz Çelik (ASTM A582 type 416-420) / Stain. Steel (ASTM A582 type 416-420)
Paslanmaz Çelik (AISI304, AISI316, duplex) / Stain. Steel (AISI304, AISI316, duplex)

Süzgeç / Filter

Paslanmaz Çelik (ASTM A582 type 420) / Stain. Steel (ASTM A582 type 420)
Paslanmaz Çelik (AISI304, AISI316) / Stain. Steel (AISI304, AISI316)



TS 11146

Pompa Tipi Pump type	Kad. Sayısı Stages	Motor		Ölçüler / Dimensions (mm)					Ağırlık / Weight (kg)		
		KW	HP	L	LM	LP	ØM	ØP	Motor Motor	Pompa Pump	Toplam Total
VRP 8035/01	1	4	5,5	1262	649	613	142	198	40	50	90
VRP 8035/02	2	5,5	7,5	1345	678	667	142	198	43,5	55	98,5
VRP 8035/03	3	7,5	10	1479	758	721	142	198	50	60	110
VRP 8035/04	4	11	15	1626	851	775	142	198	60	65	125
VRP 8035/05	5	13	17,5	1740	911	829	142	198	65	70	135
VRP 8035/06	6	15	20	1856	973	883	142	198	72	75	147
VRP 8035/07	7	18,5	25	1943	1006	937	142	198	76	80	156
VRP 8035/09	9	22	30	2151	1106	1045	142	198	87	90	177
VRP 8035/11	11	26,5	35	2370	1217	1153	142	198	98	100	198
VRP 8035/12	12	30	40	2263	1056	1207	192	198	129	105	234
VRP 8035/15	15	37	50	2485	1116	1369	192	198	138	120	258
VRP 8035/18	18	45	60	2732	1201	1531	192	198	152	135	287
VRP 8035/21	21	52	70	2979	1286	1693	192	198	170	150	320
VRP 8035/23	23	55	75	3087	1286	1801	192	198	170	160	330
VRP 8035/25	25	60	80	3250	1341	1909	192	198	185	170	355
VRP 8035/28	28	67	90	3437	1366	2071	192	198	186	185	371

Pompa Tipi Pump type	Kad. Sayısı Stages	Motor		Akım Current (A)	m ³ /h l/s	0	10	20	30	35	40	45	50
		KW	HP			0	2,78	5,56	8,33	9,72	11,11	12,50	13,89
VRP 8035/01	1	4	5,5	10,2	Basma Yüksekliği / Head (m)	22	21	20	17	15	13	10	7
VRP 8035/02	2	5,5	7,5	13,3		43	42	39	34	31	26	20	13
VRP 8035/03	3	7,5	10	17,2		65	62	59	51	46	39	30	20
VRP 8035/04	4	11	15	23,7		86	83	78	69	61	52	40	27
VRP 8035/05	5	13	17,5	28,7		108	104	98	86	76	65	50	34
VRP 8035/06	6	15	20	33,1		129	125	118	103	92	78	61	40
VRP 8035/07	7	18,5	25	41,8		151	146	137	120	107	91	71	47
VRP 8035/09	9	22	30	48,5		194	187	176	154	138	117	91	61
VRP 8035/11	11	26,5	35	56,4		237	229	216	189	168	142	111	74
VRP 8035/12	12	30	40	61,7		258	250	235	206	183	155	121	81
VRP 8035/15	15	37	50	74,3		323	312	294	257	229	194	151	101
VRP 8035/18	18	45	60	90,4		387	375	353	309	275	233	182	121
VRP 8035/21	21	52	70	103,3		452	437	412	360	321	272	212	141
VRP 8035/23	23	55	75	110,5		495	479	451	394	352	298	232	155
VRP 8035/25	25	60	80	119,1	538	521	490	429	382	324	252	168	
VRP 8035/28	28	67	90	134,6	602	583	549	480	428	362	283	188	

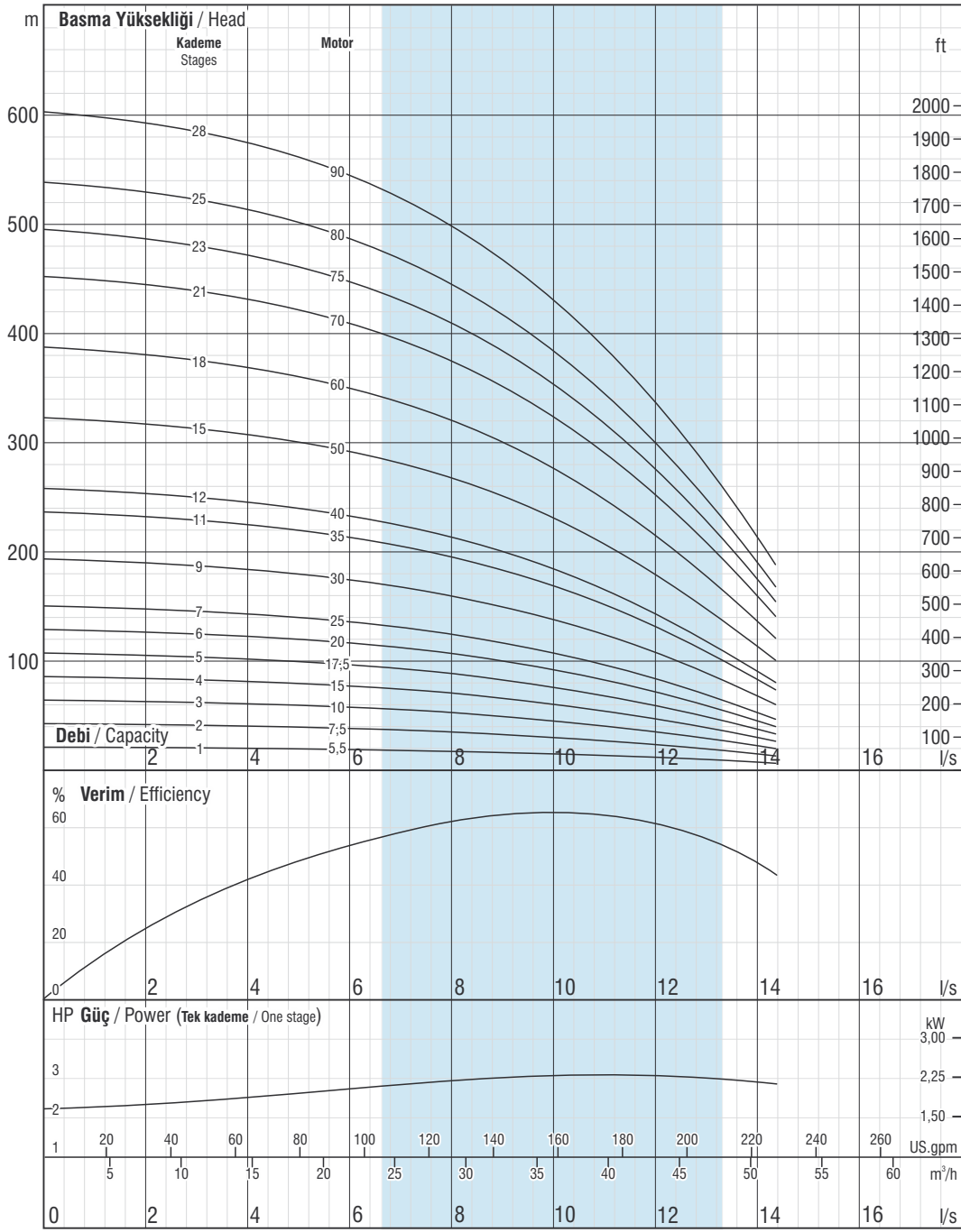

Firmamız teknolojik gelişmeler nedeniyle değişiklik hakkını saklı tutar.

Due to continuous improvement in design we reserve the right to amend specifications or data without prior notice.

VRP 08035

Çark kanat sayısı / No. of vanes
7

Çıkış haznesi bağlantısı / Outlet connection diameter
3" - 4" (içten ve dıştan pasolu)
3" - 4" (inside and outside threaded)

Pompa dış çapı / Pump outside diameter
147 mm

Dönüş Yönü / Rotation
Saatın tersi yönünde / CCW

Devir / Revolution
2900 rpm

Mil çapı / Shaft diameter
25,4 mm



Pompa performans eğrileri 1 bar atmosfer basıncı altında 15 °C sıcaklığındaki, özgül yoğunluğu 1 gr/cm³ olan su ile elde edilmiştir.

The hydraulic working characteristics have been taken with water at 15 °C, at the atmospheric pressure of 1 bar and specific gravity is 1 gr/cm³

Teknik Özellikler

Technical specifications

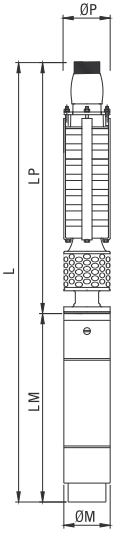

Maks. gerilim değişimi / Voltage
380-415V (+%6-%10)

Frekans / Frequency
50 Hz. / 50 Hz.

Maks. kum miktarı / Max. sand content
50 gr/m³ / 50 gr/m³

Maks. su sıcaklığı / Max. water temp.
30°C (50°C ops.) / 30°C (50°C ops.)

Opsiyonel malzemeler için lütfen irtibata geçiniz.
Please contact us for optional materials.

Ara Çanak / Diffuser

Pik Döküm (GG 20) / Cast Iron (GG 20)
Sfero Döküm (GGG40) / Ductile Iron (GGG40)
Bronz (ASTM B145-4A) / Bronze (ASTM B145-4A)
Paslanmaz Çelik (AISI304, AISI316, duplex) / Stain. Steel (AISI304, AISI316, duplex)

Çark / Impeller

Bronz (ASTM B145-4A) / Bronze (ASTM B145-4A)
Paslanmaz (AISI304, AISI316, duplex) / Stain. Steel (AISI304, AISI316, duplex)

Pompa Mili / Shaft

Paslanmaz Çelik (ASTM A582 type 416-420) / Stain. Steel (ASTM A582 type 416-420)
Paslanmaz Çelik (AISI304, AISI316, duplex) / Stain. Steel (AISI304, AISI316, duplex)

Kaplin / Coupling

Paslanmaz Çelik (ASTM A582 type 416-420) / Stain. Steel (ASTM A582 type 416-420)
Paslanmaz Çelik (AISI304, AISI316, duplex) / Stain. Steel (AISI304, AISI316, duplex)

Çark Tespit Burcu / Collet

Paslanmaz Çelik (ASTM A582 type 416-420) / Stain. Steel (ASTM A582 type 416-420)
Paslanmaz Çelik (AISI304, AISI316, duplex) / Stain. Steel (AISI304, AISI316, duplex)

Süzgeç / Filter

Paslanmaz Çelik (ASTM A582 type 420) / Stain. Steel (ASTM A582 type 420)
Paslanmaz Çelik (AISI304, AISI316) / Stain. Steel (AISI304, AISI316)



TS 11146

Pompa Tipi Pump type	Kad. Sayısı Stages	Motor		Ölçüler / Dimensions (mm)					Ağırlık / Weight (kg)		
		KW	HP	L	LM	LP	ØM	ØP	Motor Motor	Pompa Pump	Toplam Total
VRP 8050/01	1	5,5	7,5	1291	678	613	142	198	43,5	50	93,5
VRP 8050/02	2	9,3	12,5	1467	800	667	142	198	55	55	110
VRP 8050/03	3	13	17,5	1632	911	721	142	198	65	60	125
VRP 8050/04	4	18,5	25	1781	1006	775	142	198	76	65	141
VRP 8050/05	5	22	30	1935	1106	829	142	198	87	70	157
VRP 8050/06	6	26,5	35	2100	1217	883	142	198	98	75	173
VRP 8050/07	7	30	40	1993	1056	937	192	198	129	80	209
VRP 8050/08	8	37	50	2107	1116	991	192	198	138	85	223
VRP 8050/10	10	45	60	2300	1201	1099	192	198	152	95	247
VRP 8050/12	12	52	70	2493	1286	1207	192	198	170	105	275
VRP 8050/13	13	55	75	2547	1286	1261	192	198	170	110	280
VRP 8050/14	14	60	80	2656	1341	1315	192	198	185	115	300
VRP 8050/16	16	67	90	2789	1366	1423	192	198	186	125	311
VRP 8050/18	18	75	100	2922	1391	1531	192	198	195	135	330
VRP 8050/19	19	81	110	2955	1370	1585	231	198	256	140	396
VRP 8050/22	22	92	125	3177	1430	1747	231	198	284	155	439
VRP 8050/26	26	110	150	3473	1510	1963	231	198	311	175	486

Pompa Tipi Pump type	Kad. Sayısı Stages	Motor		Akım Current (A)	m ³ /h l/s	0	30	40	50	55	60	70	80
		KW	HP			0	8,33	11,11	13,89	15,28	16,67	19,44	22,22
VRP 8050/01	1	5,5	7,5	13,3	Basma Yüksekliği / Head (m)	25	23	21	19	18	17	13	9
VRP 8050/02	2	9,3	12,5	20,8		50	45	43	39	37	34	27	18
VRP 8050/03	3	13	17,5	28,7		75	68	64	58	55	50	40	27
VRP 8050/04	4	18,5	25	41,8		100	91	86	78	73	67	53	36
VRP 8050/05	5	22	30	48,5		124	113	107	97	91	84	66	45
VRP 8050/06	6	26,5	35	56,4		149	136	128	117	110	101	80	54
VRP 8050/07	7	30	40	61,7		174	158	150	136	128	118	93	63
VRP 8050/08	8	37	50	74,3		199	181	171	156	146	134	106	72
VRP 8050/10	10	45	60	90,4		249	226	214	195	183	168	133	90
VRP 8050/12	12	52	70	103,3		299	272	257	234	219	202	160	107
VRP 8050/13	13	55	75	110,5		323	294	278	253	237	219	173	116
VRP 8050/14	14	60	80	119,1		348	317	299	273	256	235	186	125
VRP 8050/16	16	67	90	134,6		398	362	342	312	292	269	213	143
VRP 8050/18	18	75	100	150,7		448	407	385	351	329	303	239	161
VRP 8050/19	19	81	110	159	473	430	406	370	347	319	253	170	
VRP 8050/22	22	92	125	179	547	498	470	429	402	370	293	197	
VRP 8050/26	26	110	150	216	647	588	556	507	475	437	346	233	

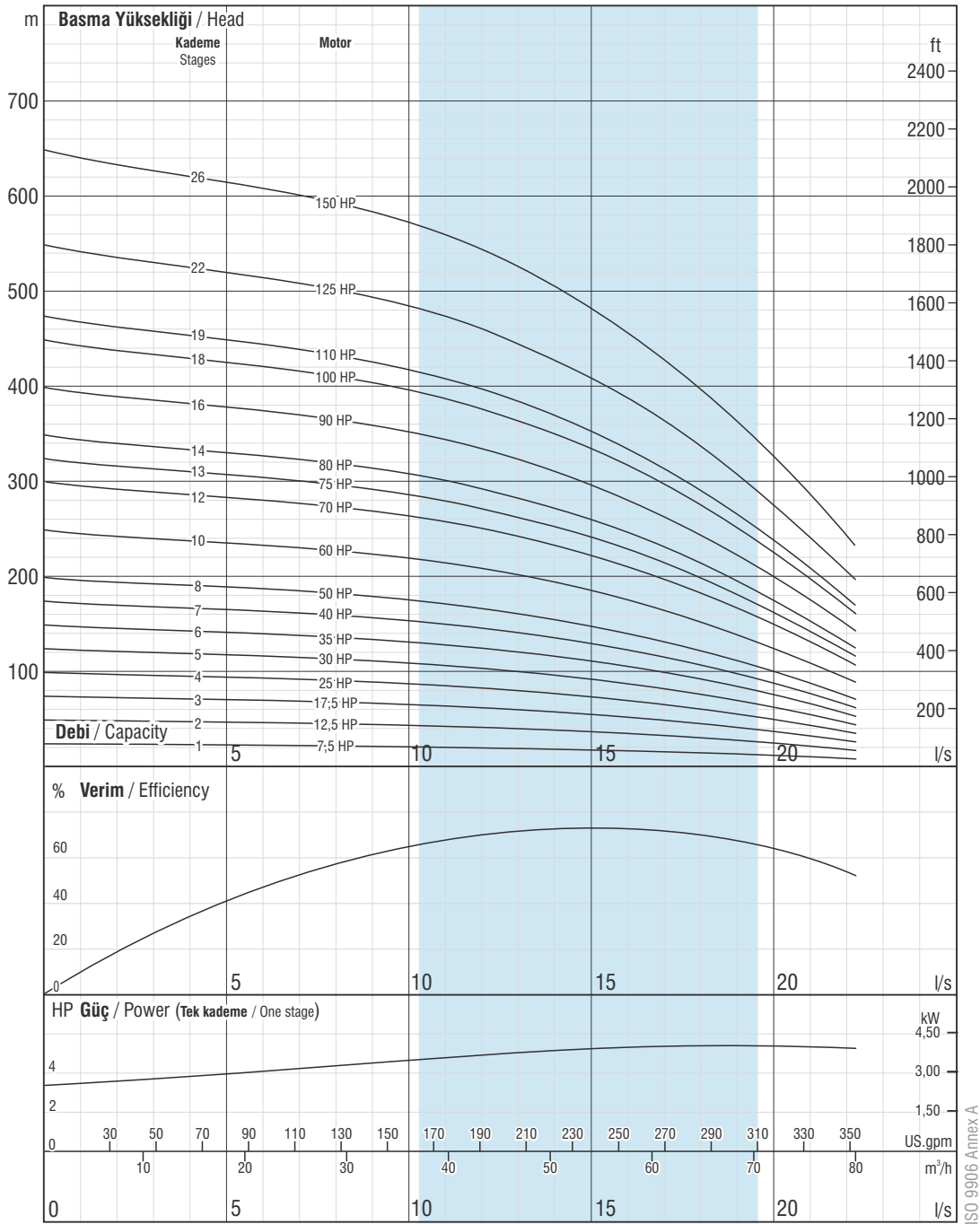

Firmamız teknolojik gelişmeler nedeniyle değişiklik hakkını saklı tutar.

Due to continuous improvement in design we reserve the right to amend specifications or data without prior notice.

VRP 08050

Çark kanat sayısı / No. of vanes
7

Çıkış haznesi bağlantısı / Outlet connection diameter
3" - 4" (içten ve dıştan pasolu)
3" - 4" (inside and outside threaded)

Pompa dış çapı / Pump outside diameter
147 mm

Dönüş Yönü / Rotation
Saatin tersi yönünde / CCW

Devir / Revolution
2900 rpm

Mil çapı / Shaft diameter
25,4 mm



Pompa performans eğrileri 1 bar atmosfer basıncı altında 15 °C sıcaklığındaki, özgül yoğunluğu 1 gr/cm³ olan su ile elde edilmiştir.

The hydraulic working characteristics have been taken with water at 15 °C, at the atmospheric pressure of 1 bar and specific gravity is 1 gr/cm³

Teknik Özellikler

Technical specifications

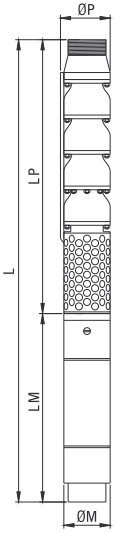

Maks. gerilim değişimi / Voltage
380-415V (+%6-%10)

Frekans / Frequency
50 Hz. / 50 Hz.

Maks. kum miktarı / Max. sand content
50 gr/m³ / 50 gr/m³

Maks. su sıcaklığı / Max. water temp.
30°C (50°C ops.) / 30°C (50°C ops.)

Opsiyonel malzemeler için lütfen irtibata geçiniz.
Please contact us for optional materials.

Ara Çanak / Diffuser

Pik Döküm (GG 20) / Cast Iron (GG 20)
Sfero Döküm (GGG40) / Ductile Iron (GGG40)
Bronz (ASTM B145-4A) / Bronze (ASTM B145-4A)
Paslanmaz Çelik (AISI304, AISI316, duplex) / Stain. Steel (AISI304, AISI316, duplex)

Çark / Impeller

Pik Döküm (GG 20) / Cast Iron (GG 20)
Sfero Döküm (GGG40) / Ductile Iron (GGG40)
Bronz (ASTM B145-4A) / Bronze (ASTM B145-4A)
Paslanmaz Çelik (AISI304, AISI316, duplex) / Stain. Steel (AISI304, AISI316, duplex)

Pompa Mili / Shaft

Paslanmaz Çelik (ASTM A582 type 416-420) / Stain. Steel (ASTM A582 type 416-420)
Paslanmaz Çelik (AISI304, AISI316, duplex) / Stain. Steel (AISI304, AISI316, duplex)

Kaplin / Coupling

Paslanmaz Çelik (ASTM A582 type 416-420) / Stain. Steel (ASTM A582 type 416-420)
Paslanmaz Çelik (AISI304, AISI316, duplex) / Stain. Steel (AISI304, AISI316, duplex)

Çark Tespit Burcu / Collet

Paslanmaz Çelik (ASTM A582 type 416-420) / Stain. Steel (ASTM A582 type 416-420)
Paslanmaz Çelik (AISI304, AISI316, duplex) / Stain. Steel (AISI304, AISI316, duplex)

Süzgeç / Filter

Paslanmaz Çelik (ASTM A582 type 420) / Stain. Steel (ASTM A582 type 420)
Paslanmaz Çelik (AISI304, AISI316) / Stain. Steel (AISI304, AISI316)



TS 11146

Pompa Tipi Pump type	Kad. Sayısı Stages	Motor		Ölçüler / Dimensions (mm)					Ağırlık / Weight (kg)		
		KW	HP	L	LM	LP	ØM	ØP	Motor Motor	Pompa Pump	Toplam Total
VSP 0831/01	1	7,5	10	1447	758	689	142	203	50	37	87
VSP 0831/02	2	13	17,5	1765	911	854	142	203	65	54	119
VSP 0831/03	3	22	30	2125	1106	1019	142	203	87	70	157
VSP 0831/04	4	26,5	35	2401	1217	1184	142	203	98	86	184
VSP 0831/05	5	37	50	2465	1116	1349	192	203	138	102	240
VSP 0831/07	7	45	60	2880	1201	1679	192	203	152	134	286
VSP 0831/08	8	52	70	3130	1286	1844	192	203	170	150	320
VSP 0831/09	9	60	80	3350	1341	2009	192	203	185	167	352
VSP 0831/10	10	67	90	3540	1366	2174	192	203	186	183	369
VSP 0831/12	12	75	100	3895	1391	2504	192	203	195	215	410
VSP 0831/14	14	92	125	4264	1430	2834	231	203	284	247	531
VSP 0831/17	17	110	150	4839	1510	3329	231	203	311	296	607
VSP 0831/20	20	129	175	5434	1610	3824	231	203	338	344	682
VSP 0831/23	23	147	200	6059	1740	4319	231	203	370	393	763

Pompa Tipi Pump type	Kad. Sayısı Stages	Motor		Akım Current (A)	m ³ /h l/s	0	30	50	70	80	90	100	130
		KW	HP			0	8,33	13,89	19,44	22,22	25,00	27,78	36,11
VSP 0831/01	1	7,5	10	17,2	Basma Yüksekliği / Head (m)	28	25	24	21	20	18	16	9
VSP 0831/02	2	13	17,5	28,7		56	50	47	43	40	36	33	18
VSP 0831/03	3	22	30	48,5		84	76	71	64	60	55	49	27
VSP 0831/04	4	26,5	35	56,4		112	101	94	85	80	73	65	36
VSP 0831/05	5	37	50	74,3		140	126	118	107	100	91	82	45
VSP 0831/07	7	45	60	90,4		195	176	165	149	139	128	114	63
VSP 0831/08	8	52	70	103,3		223	202	188	171	159	146	130	72
VSP 0831/09	9	60	80	119,1		251	227	212	192	179	164	147	81
VSP 0831/10	10	67	90	134,6		279	252	235	213	199	182	163	90
VSP 0831/12	12	75	100	150,7		335	302	283	256	239	219	196	108
VSP 0831/14	14	92	125	179		391	353	330	299	279	255	228	126
VSP 0831/17	17	110	150	216		474	428	400	363	339	310	277	153
VSP 0831/20	20	129	175	248		558	504	471	427	398	365	326	180
VSP 0831/23	23	147	200	282	642	580	542	491	458	420	375	207	

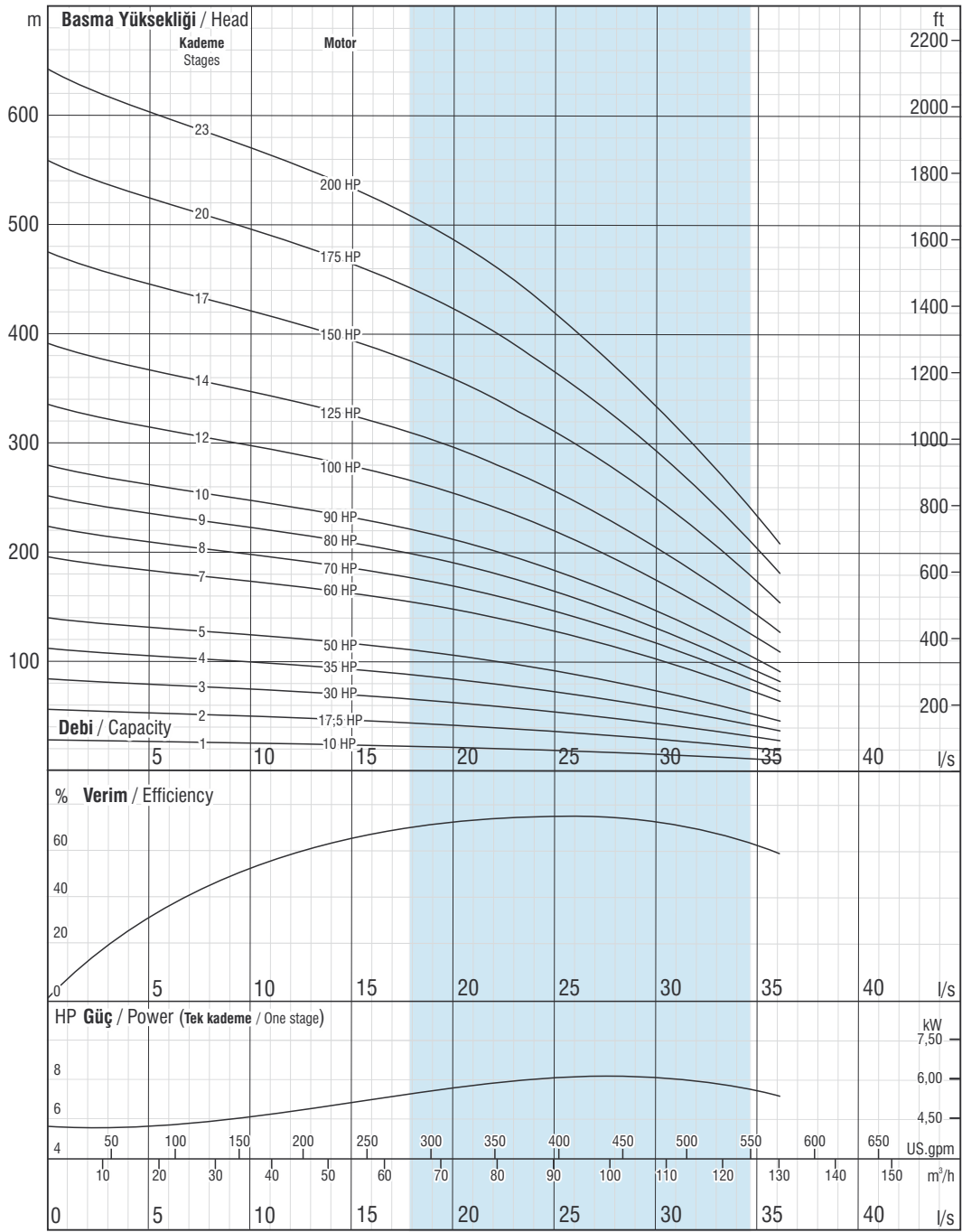

Firmamız teknolojik gelişmeler nedeniyle değişiklik hakkını saklı tutar.

Due to continuous improvement in design we reserve the right to amend specifications or data without prior notice.

VSP 0831

Çark kanat sayısı / No. of vanes
5

Çıkış haznesi bağlantısı / Outlet connection diameter
5" - 6" (içten ve dıştan pasolu)
5" - 6" (inside and outside threaded)

Pompa dış çapı / Pump outside diameter
203 mm

Dönüş Yönü / Rotation
Saatin tersi yönünde / CCW

Devir / Revolution
2900 rpm

Mil çapı / Shaft diameter
30,16 mm



Pompa performans eğrileri 1 bar atmosfer basıncı altında 15 °C sıcaklığındaki, özgül yoğunluğu 1 gr/cm³ olan su ile elde edilmiştir.

The hydraulic working characteristics have been taken with water at 15 °C, at the atmospheric pressure of 1 bar and specific gravity is 1 gr/cm³

Teknik Özellikler

Technical specifications

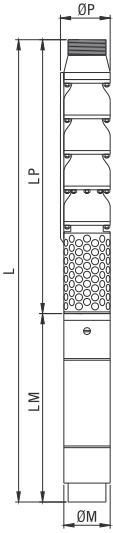

Maks. gerilim değişimi / Voltage
380-415V (+%6-%10)

Frekans / Frequency
50 Hz. / 50 Hz.

Maks. kum miktarı / Max. sand content
50 gr/m³ / 50 gr/m³

Maks. su sıcaklığı / Max. water temp.
30°C (50°C ops.) / 30°C (50°C ops.)

Opsiyonel malzemeler için lütfen irtibata geçiniz.
Please contact us for optional materials.

Ara Çanak / Diffuser

Pik Döküm (GG 20) / Cast Iron (GG 20)
Sfero Döküm (GGG40) / Ductile Iron (GGG40)
Bronz (ASTM B145-4A) / Bronze (ASTM B145-4A)
Paslanmaz Çelik (AISI304, AISI316, duplex) / Stain. Steel (AISI304, AISI316, duplex)

Çark / Impeller

Pik Döküm (GG 20) / Cast Iron (GG 20)
Sfero Döküm (GGG40) / Ductile Iron (GGG40)
Bronz (ASTM B145-4A) / Bronze (ASTM B145-4A)
Paslanmaz Çelik (AISI304, AISI316, duplex) / Stain. Steel (AISI304, AISI316, duplex)

Pompa Mili / Shaft

Paslanmaz Çelik (ASTM A582 type 416-420) / Stain. Steel (ASTM A582 type 416-420)
Paslanmaz Çelik (AISI304, AISI316, duplex) / Stain. Steel (AISI304, AISI316, duplex)

Kaplin / Coupling

Paslanmaz Çelik (ASTM A582 type 416-420) / Stain. Steel (ASTM A582 type 416-420)
Paslanmaz Çelik (AISI304, AISI316, duplex) / Stain. Steel (AISI304, AISI316, duplex)

Çark Tespit Burcu / Collet

Paslanmaz Çelik (ASTM A582 type 416-420) / Stain. Steel (ASTM A582 type 416-420)
Paslanmaz Çelik (AISI304, AISI316, duplex) / Stain. Steel (AISI304, AISI316, duplex)

Süzgeç / Filter

Paslanmaz Çelik (ASTM A582 type 420) / Stain. Steel (ASTM A582 type 420)
Paslanmaz Çelik (AISI304, AISI316) / Stain. Steel (AISI304, AISI316)



TS 11146

Pompa Tipi Pump type	Kad. Sayısı Stages	Motor		Ölçüler / Dimensions (mm)					Ağırlık / Weight (kg)		
		KW	HP	L	LM	LP	ØM	ØP	Motor Motor	Pompa Pump	Toplam Total
VSP 0832/01	1	7,5	10	1447	758	689	142	203	50	37	87
VSP 0832/02	2	15	20	1827	973	854	142	203	72	54	126
VSP 0832/03	3	22	30	2125	1106	1019	142	203	87	70	157
VSP 0832/04	4	30	40	2240	1056	1184	192	203	129	86	215
VSP 0832/05	5	37	50	2465	1116	1349	192	203	138	102	240
VSP 0832/06	6	45	60	2715	1201	1514	192	203	152	118	270
VSP 0832/07	7	52	70	2965	1286	1679	192	203	170	134	304
VSP 0832/08	8	60	80	3185	1341	1844	192	203	185	150	335
VSP 0832/09	9	67	90	3375	1366	2009	192	203	186	167	353
VSP 0832/10	10	75	100	3565	1391	2174	192	203	195	183	378
VSP 0832/11	11	81	110	3709	1370	2339	231	203	256	199	455
VSP 0832/13	13	92	125	4099	1430	2669	231	203	284	231	515
VSP 0832/15	15	110	150	4509	1510	2999	231	203	311	264	575
VSP 0832/18	18	129	175	5104	1610	3494	231	203	338	312	650
VSP 0832/21	21	147	200	5729	1740	3989	231	203	370	360	730

Pompa Tipi Pump type	Kad. Sayısı Stages	Motor		Akım Current (A)	m ³ /h I/s	0	40	70	100	110	120	140	160
		KW	HP			0	11,11	19,44	27,78	30,56	33,33	38,89	44,44
VSP 0832/01	1	7,5	10	17,2	Basma Yüksekliği / Head (m)	27	25	22	19	17	16	11	6
VSP 0832/02	2	15	20	33,1		55	50	45	38	35	31	23	12
VSP 0832/03	3	22	30	48,5		82	75	67	57	52	47	34	18
VSP 0832/04	4	30	40	61,7		109	100	90	76	69	63	46	24
VSP 0832/05	5	37	50	74,3		137	125	112	94	87	78	57	30
VSP 0832/06	6	45	60	90,4		164	150	135	113	104	94	69	36
VSP 0832/07	7	52	70	103,3		191	175	157	132	122	110	80	42
VSP 0832/08	8	60	80	119,1		218	200	180	151	139	125	92	47
VSP 0832/09	9	67	90	134,6		246	225	202	170	156	141	103	53
VSP 0832/10	10	75	100	150,7		273	250	225	189	174	157	115	59
VSP 0832/11	11	81	110	159		300	275	247	208	191	172	126	65
VSP 0832/13	13	92	125	179		355	325	292	245	226	204	149	77
VSP 0832/15	15	110	150	216		410	375	337	283	261	235	172	89
VSP 0832/18	18	129	175	248		492	451	404	340	313	282	206	107
VSP 0832/21	21	147	200	282		573	526	472	396	365	329	241	125

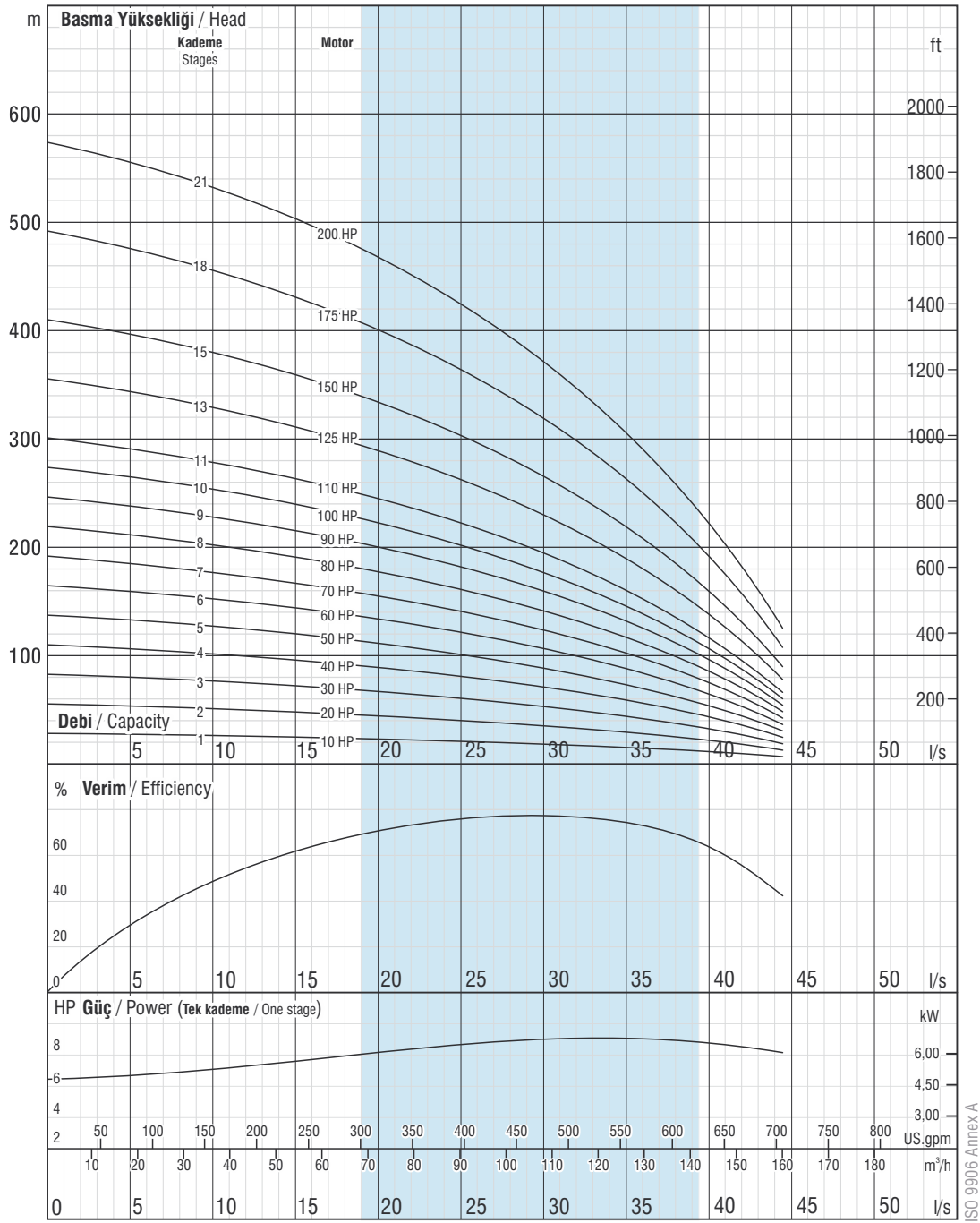

Firmamız teknolojik gelişmeler nedeniyle değişiklik hakkını saklı tutar.

Due to continuous improvement in design we reserve the right to amend specifications or data without prior notice.

VSP 0832

Çark kanat sayısı / No. of vanes
5

Çıkış haznesi bağlantısı / Outlet connection diameter
5" - 6" (içten ve dıştan pasolu)
5" - 6" (inside and outside threaded)

Pompa dış çapı / Pump outside diameter
203 mm

Dönüş Yönü / Rotation
Saatin tersi yönünde / CCW

Devir / Revolution
2900 rpm

Mil çapı / Shaft diameter
30,16 mm



Pompa performans eğrileri 1 bar atmosfer basıncı altında 15 °C sıcaklığındaki, özgül yoğunluğu 1 gr/cm³ olan su ile elde edilmiştir.
The hydraulic working characteristics have been taken with water at 15 °C, at the atmospheric pressure of 1 bar and specific gravity is 1 gr/cm³

Teknik Özellikler

Technical specifications

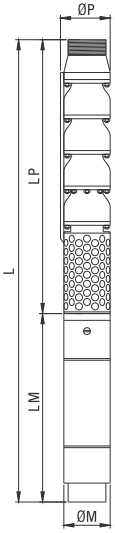

Maks. gerilim değişimi / Voltage
380-415V (+%6-%10)

Frekans / Frequency
50 Hz. / 50 Hz.

Maks. kum miktarı / Max. sand content
50 gr/m³ / 50 gr/m³

Maks. su sıcaklığı / Max. water temp.
30°C (50°C ops.) / 30°C (50°C ops.)

Opsiyonel malzemeler için lütfen irtibata geçiniz.
Please contact us for optional materials.

Ara Çanak / Diffuser

Pik Döküm (GG 20) / Cast Iron (GG 20)
Sfero Döküm (GGG40) / Ductile Iron (GGG40)
Bronz (ASTM B145-4A) / Bronze (ASTM B145-4A)
Paslanmaz Çelik (AISI304, AISI316, duplex) / Stain. Steel (AISI304, AISI316, duplex)

Çark / Impeller

Pik Döküm (GG 20) / Cast Iron (GG 20)
Sfero Döküm (GGG40) / Ductile Iron (GGG40)
Bronz (ASTM B145-4A) / Bronze (ASTM B145-4A)
Paslanmaz (AISI304, AISI316, duplex) / Stain. Steel (AISI304, AISI316, duplex)

Pompa Mili / Shaft

Paslanmaz Çelik (ASTM A582 type 416-420) / Stain. Steel (ASTM A582 type 416-420)
Paslanmaz Çelik (AISI304, AISI316, duplex) / Stain. Steel (AISI304, AISI316, duplex)

Kaplin / Coupling

Paslanmaz Çelik (ASTM A582 type 416-420) / Stain. Steel (ASTM A582 type 416-420)
Paslanmaz Çelik (AISI304, AISI316, duplex) / Stain. Steel (AISI304, AISI316, duplex)

Çark Tespit Burcu / Collet

Paslanmaz Çelik (ASTM A582 type 416-420) / Stain. Steel (ASTM A582 type 416-420)
Paslanmaz Çelik (AISI304, AISI316, duplex) / Stain. Steel (AISI304, AISI316, duplex)

Süzgeç / Filter

Paslanmaz Çelik (ASTM A582 type 420) / Stain. Steel (ASTM A582 type 420)
Paslanmaz Çelik (AISI304, AISI316) / Stain. Steel (AISI304, AISI316)



TS 11146

Pompa Tipi Pump type	Kad. Sayısı Stages	Motor		Ölçüler / Dimensions (mm)					Ağırlık / Weight (kg)		
		KW	HP	L	LM	LP	ØM	ØP	Motor Motor	Pompa Pump	Toplam Total
VSP 0833/02B	2	15	20	1827	973	854	142	203	72	54	126
VSP 0833/02	2	18,5	25	1860	1006	854	142	203	76	54	130
VSP 0833/03B	3	22	30	2125	1106	1019	142	203	87	70	157
VSP 0833/03	3	26,5	35	2236	1217	1019	142	203	98	70	168
VSP 0833/04B	4	30	40	2431	1247	1184	142	203	103	86	189
VSP 0833/05B	5	37	50	2465	1116	1349	192	203	138	102	240
VSP 0833/06B	6	45	60	2715	1201	1514	192	203	152	118	270
VSP 0833/06	6	52	70	2800	1286	1514	192	203	170	118	288
VSP 0833/07	7	55	75	2965	1286	1679	192	203	170	134	304
VSP 0833/08	8	67	90	3210	1366	1844	192	203	186	150	336
VSP 0833/09	9	75	100	3400	1391	2009	192	203	195	167	362
VSP 0833/10	10	81	110	3544	1370	2174	231	203	256	183	439
VSP 0833/12	12	92	125	3934	1430	2504	231	203	284	215	499
VSP 0833/14	14	110	150	4344	1510	2834	231	203	311	247	558
VSP 0833/16	16	129	175	4774	1610	3164	231	203	338	280	618
VSP 0833/19	19	147	200	5399	1740	3659	231	203	370	328	698

Pompa Tipi Pump type	Kad. Sayısı Stages	Motor		Akım Current (A)	m ³ /h l/s	0	40	90	100	110	120	140	170
		KW	HP			0	11,11	25,00	27,78	30,56	33,33	38,89	47,22
VSP 0833/02B	2	15	20	33,1	Basma Yüksekliği / Head (m)	54	48	39	36	33	31	24	11
VSP 0833/02	2	18,5	25	41,8		58	52	43	40	38	35	28	14
VSP 0833/03B	3	22	30	48,5		81	72	58	54	50	46	36	17
VSP 0833/03	3	26,5	35	56,4		88	78	64	60	56	52	42	21
VSP 0833/04B	4	30	40	64,6		108	96	77	72	67	61	47	22
VSP 0833/05B	5	37	50	74,3		135	121	97	90	84	76	59	28
VSP 0833/06B	6	45	60	90,4		162	145	116	109	100	92	71	33
VSP 0833/06	6	52	70	103,3		175	156	128	121	113	104	83	43
VSP 0833/07	7	55	75	110,5		205	182	149	141	132	121	97	50
VSP 0833/08	8	67	90	134,6		234	207	171	161	151	139	111	57
VSP 0833/09	9	75	100	150,7		263	233	192	181	169	156	125	64
VSP 0833/10	10	81	110	159		292	259	213	201	188	173	139	71
VSP 0833/12	12	92	125	179		351	311	256	242	226	208	167	85
VSP 0833/14	14	110	150	216		409	363	298	282	263	243	194	99
VSP 0833/16	16	129	175	248		468	415	341	322	301	278	222	113
VSP 0833/19	19	147	200	282		555	493	405	382	357	330	264	135

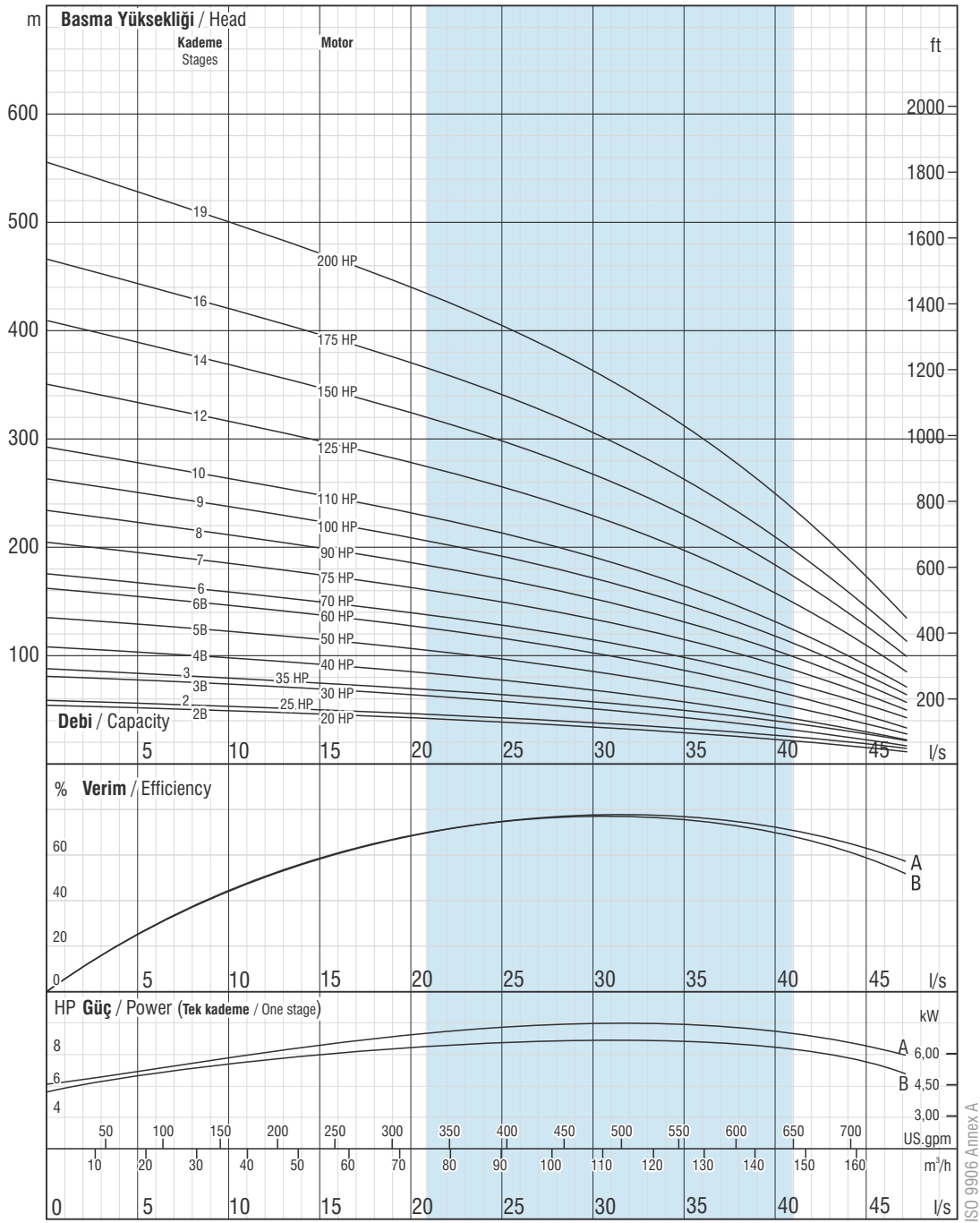

Firmamız teknolojik gelişmeler nedeniyle değişiklik hakkını saklı tutar.

Due to continuous improvement in design we reserve the right to amend specifications or data without prior notice.

VSP 0833

Çark kanat sayısı / No. of vanes
6

Çıkış haznesi bağlantısı / Outlet connection diameter
5" - 6" (içten ve dıştan pasolu)
5" - 6" (inside and outside threaded)

Pompa dış çapı / Pump outside diameter
203 mm

Dönüş Yönü / Rotation
Saatin tersi yönünde / CCW

Devir / Revolution
2900 rpm

Mil çapı / Shaft diameter
30,16 mm



Pompa performans eğrileri 1 bar atmosfer basıncı altında 15 °C sıcaklığındaki, özgül yoğunluğu 1 gr/cm³ olan su ile elde edilmiştir.

The hydraulic working characteristics have been taken with water at 15 °C, at the atmospheric pressure of 1 bar and specific gravity is 1 gr/cm³

Teknik Özellikler

Technical specifications

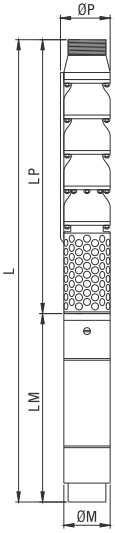

Maks. gerilim değişimi / Voltage
380-415V (+%6-%10)

Frekans / Frequency
50 Hz. / 50 Hz.

Maks. kum miktarı / Max. sand content
50 gr/m³ / 50 gr/m³

Maks. su sıcaklığı / Max. water temp.
30°C (50°C ops.) / 30°C (50°C ops.)

Opsiyonel malzemeler için lütfen irtibata geçiniz.
Please contact us for optional materials.

Ara Çanak / Diffuser

Pik Döküm (GG 20) / Cast Iron (GG 20)
Sfero Döküm (GGG40) / Ductile Iron (GGG40)
Bronz (ASTM B145-4A) / Bronze (ASTM B145-4A)
Paslanmaz Çelik (AISI304, AISI316, duplex) / Stain. Steel (AISI304, AISI316, duplex)

Çark / Impeller

Pik Döküm (GG 20) / Cast Iron (GG 20)
Sfero Döküm (GGG40) / Ductile Iron (GGG40)
Bronz (ASTM B145-4A) / Bronze (ASTM B145-4A)
Paslanmaz (AISI304, AISI316, duplex) / Stain. Steel (AISI304, AISI316, duplex)

Pompa Mili / Shaft

Paslanmaz Çelik (ASTM A582 type 416-420) / Stain. Steel (ASTM A582 type 416-420)
Paslanmaz Çelik (AISI304, AISI316, duplex) / Stain. Steel (AISI304, AISI316, duplex)

Kaplin / Coupling

Paslanmaz Çelik (ASTM A582 type 416-420) / Stain. Steel (ASTM A582 type 416-420)
Paslanmaz Çelik (AISI304, AISI316, duplex) / Stain. Steel (AISI304, AISI316, duplex)

Çark Tespit Burcu / Collet

Paslanmaz Çelik (ASTM A582 type 416-420) / Stain. Steel (ASTM A582 type 416-420)
Paslanmaz Çelik (AISI304, AISI316, duplex) / Stain. Steel (AISI304, AISI316, duplex)

Süzgeç / Filter

Paslanmaz Çelik (ASTM A582 type 420) / Stain. Steel (ASTM A582 type 420)
Paslanmaz Çelik (AISI304, AISI316) / Stain. Steel (AISI304, AISI316)



TS 11146

Pompa Tipi Pump type	Kad. Sayısı Stages	Motor		Ölçüler / Dimensions (mm)					Ağırlık / Weight (kg)		
		KW	HP	L	LM	LP	ØM	ØP	Motor Motor	Pompa Pump	Toplam Total
VSP 0834/01	1	13	17,5	1600	911	689	142	203	65	37	102
VSP 0834/02B	2	18,5	25	1860	1006	854	142	203	76	54	130
VSP 0834/02	2	26,5	35	2071	1217	854	142	203	98	54	152
VSP 0834/03B	3	30	40	2266	1247	1019	142	203	103	70	173
VSP 0834/03	3	37	50	2135	1116	1019	192	203	138	70	208
VSP 0834/04	4	52	70	2470	1286	1184	192	203	170	86	256
VSP 0834/05	5	60	80	2690	1341	1349	192	203	185	102	287
VSP 0834/06	6	75	100	2905	1391	1514	192	203	195	118	313
VSP 0834/07	7	92	125	3109	1430	1679	231	203	284	134	418
VSP 0834/09	9	110	150	3519	1510	2009	231	203	311	167	478
VSP 0834/11	11	129	175	3949	1610	2339	231	203	338	199	537
VSP 0834/12	12	147	200	4244	1740	2504	231	203	370	215	585

Pompa Tipi Pump type	Kad. Sayısı Stages	Motor		Akım Current (A)	m ³ /h l/s	0	40	80	100	120	140	160	190
		KW	HP			0	11,11	22,22	27,78	33,33	38,89	44,44	52,78
VSP 0834/01	1	13	17,5	28,7	Basma Yüksekliği / Head (m)	29	28	25	23	21	20	17	12
VSP 0834/02B	2	18,5	25	41,8		54	51	45	42	38	34	28	14
VSP 0834/02	2	26,5	35	56,4		59	55	49	46	43	39	34	23
VSP 0834/03B	3	30	40	64,6		81	76	67	62	57	51	42	21
VSP 0834/03	3	37	50	74,3		88	83	74	69	64	59	51	35
VSP 0834/04	4	52	70	103,3		117	110	99	92	86	78	69	47
VSP 0834/05	5	60	80	119,1		147	138	123	115	107	98	86	59
VSP 0834/06	6	75	100	150,7		176	165	148	139	129	117	103	70
VSP 0834/07	7	92	125	179		205	193	173	162	150	137	120	82
VSP 0834/09	9	110	150	216		264	248	222	208	193	176	154	106
VSP 0834/11	11	129	175	248		322	303	271	254	236	215	189	129
VSP 0834/12	12	147	200	282		352	331	296	277	257	235	206	141

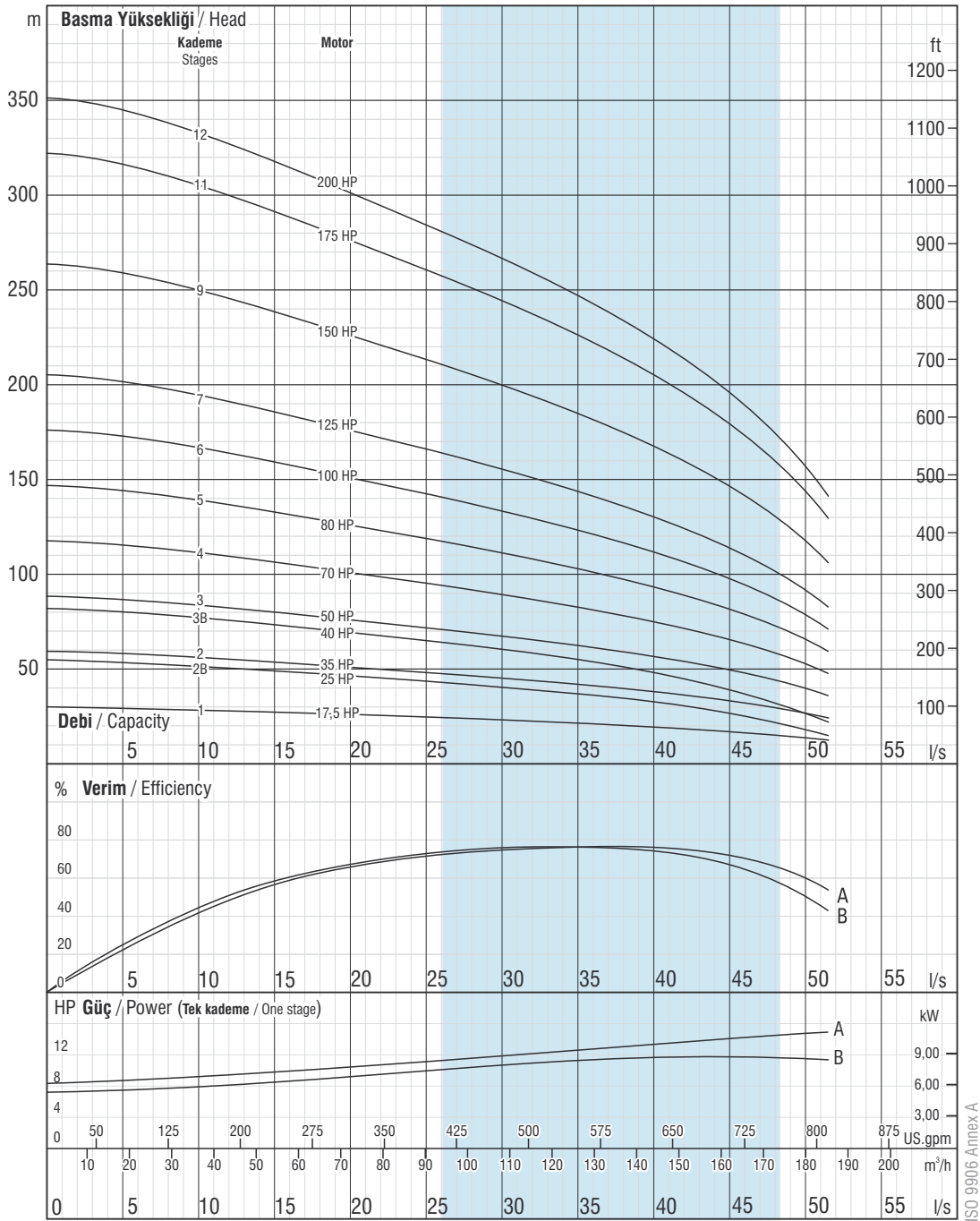

Firmamız teknolojik gelişmeler nedeniyle değişiklik hakkını saklı tutar.

Due to continuous improvement in design we reserve the right to amend specifications or data without prior notice.

VSP 0834

Çark kanat sayısı / No. of vanes
8

Çıkış haznesi bağlantısı / Outlet connection diameter
5" - 6" (içten ve dıştan pasolu)
5" - 6" (inside and outside threaded)

Pompa dış çapı / Pump outside diameter
203 mm

Dönüş Yönü / Rotation
Saatin tersi yönünde / CCW

Devir / Revolution
2900 rpm

Mil çapı / Shaft diameter
30,16 mm



Pompa performans eğrileri 1 bar atmosfer basıncı altında 15 °C sıcaklığındaki, özgül yoğunluğu 1 gr/cm³ olan su ile elde edilmiştir.

The hydraulic working characteristics have been taken with water at 15 °C, at the atmospheric pressure of 1 bar and specific gravity is 1 gr/cm³

Teknik Özellikler

Technical specifications

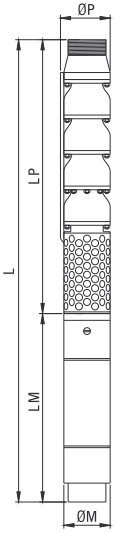

Maks. gerilim değişimi / Voltage
380-415V (+%6-%10)

Frekans / Frequency
50 Hz. / 50 Hz.

Maks. kum miktarı / Max. sand content
50 gr/m³ / 50 gr/m³

Maks. su sıcaklığı / Max. water temp.
30°C (50°C ops.) / 30°C (50°C ops.)

Opsiyonel malzemeler için lütfen irtibata geçiniz.
Please contact us for optional materials.

Ara Çanak / Diffuser

Pik Döküm (GG 20) / Cast Iron (GG 20)
Sfero Döküm (GGG40) / Ductile Iron (GGG40)
Bronz (ASTM B145-4A) / Bronze (ASTM B145-4A)
Paslanmaz Çelik (AISI304, AISI316, duplex) / Stain. Steel (AISI304, AISI316, duplex)

Çark / Impeller

Pik Döküm (GG 20) / Cast Iron (GG 20)
Sfero Döküm (GGG40) / Ductile Iron (GGG40)
Bronz (ASTM B145-4A) / Bronze (ASTM B145-4A)
Paslanmaz (AISI304, AISI316, duplex) / Stain. Steel (AISI304, AISI316, duplex)

Pompa Mili / Shaft

Paslanmaz Çelik (ASTM A582 type 416-420) / Stain. Steel (ASTM A582 type 416-420)
Paslanmaz Çelik (AISI304, AISI316, duplex) / Stain. Steel (AISI304, AISI316, duplex)

Kaplin / Coupling

Paslanmaz Çelik (ASTM A582 type 416-420) / Stain. Steel (ASTM A582 type 416-420)
Paslanmaz Çelik (AISI304, AISI316, duplex) / Stain. Steel (AISI304, AISI316, duplex)

Çark Tespit Burcu / Collet

Paslanmaz Çelik (ASTM A582 type 416-420) / Stain. Steel (ASTM A582 type 416-420)
Paslanmaz Çelik (AISI304, AISI316, duplex) / Stain. Steel (AISI304, AISI316, duplex)

Süzgeç / Filter

Paslanmaz Çelik (ASTM A582 type 420) / Stain. Steel (ASTM A582 type 420)
Paslanmaz Çelik (AISI304, AISI316) / Stain. Steel (AISI304, AISI316)



TS 11146

Pompa Tipi Pump type	Kad. Sayısı Stages	Motor		Ölçüler / Dimensions (mm)					Ağırlık / Weight (kg)		
		KW	HP	L	LM	LP	ØM	ØP	Motor Motor	Pompa Pump	Toplam Total
VSP 0853/01	1	13	17,5	1625	911	714	142	205	65	36	101
VSP 0853/02B	2	22	30	2011	1106	905	142	205	87	58	145
VSP 0853/02	2	26,5	35	2122	1217	905	142	205	98	58	156
VSP 0853/03B	3	37	50	2211	1116	1095	192	205	138	80	218
VSP 0853/03	3	45	60	2296	1201	1095	192	205	152	80	232
VSP 0853/04	4	52	70	2572	1286	1286	192	205	170	101	271
VSP 0853/05B	5	55	75	2763	1286	1477	192	205	170	123	293
VSP 0853/05	5	67	90	2843	1366	1477	192	205	186	123	309
VSP 0853/06	6	81	110	3037	1370	1667	231	205	256	145	401
VSP 0853/07	7	92	125	3288	1430	1858	231	205	284	167	451
VSP 0853/08	8	110	150	3558	1510	2048	231	205	311	189	500
VSP 0853/09	9	129	175	3849	1610	2239	231	205	338	211	549
VSP 0853/11	11	147	200	4360	1740	2620	231	205	370	254	624

Pompa Tipi Pump type	Kad. Sayısı Stages	Motor		Akım Current (A)	m ³ /h l/s	0	50	100	150	175	200	225	260
		KW	HP			0	13,89	27,78	41,67	48,61	55,56	62,50	72,22
VSP 0853/01	1	13	17,5	28,7	Basma Yüksekliği / Head (m)	33	29	25	21	19	17	15	9
VSP 0853/02B	2	22	30	48,5		56	49	42	35	32	28	23	12
VSP 0853/02	2	26,5	35	56,4		66	58	50	42	39	34	29	19
VSP 0853/03B	3	37	50	74,3		85	74	63	53	48	42	34	18
VSP 0853/03	3	45	60	90,4		99	87	74	63	58	52	44	28
VSP 0853/04	4	52	70	103,3		132	116	99	85	77	69	59	38
VSP 0853/05B	5	55	75	110,5		141	123	104	88	80	70	57	31
VSP 0853/05	5	67	90	134,6		165	145	124	106	97	86	73	47
VSP 0853/06	6	81	110	159		198	174	149	127	116	103	88	57
VSP 0853/07	7	92	125	179		231	202	174	148	135	121	103	66
VSP 0853/08	8	110	150	216		264	231	198	169	154	138	117	76
VSP 0853/09	9	129	175	248	297	260	223	190	174	155	132	85	
VSP 0853/11	11	147	200	282	363	318	273	232	212	190	161	104	

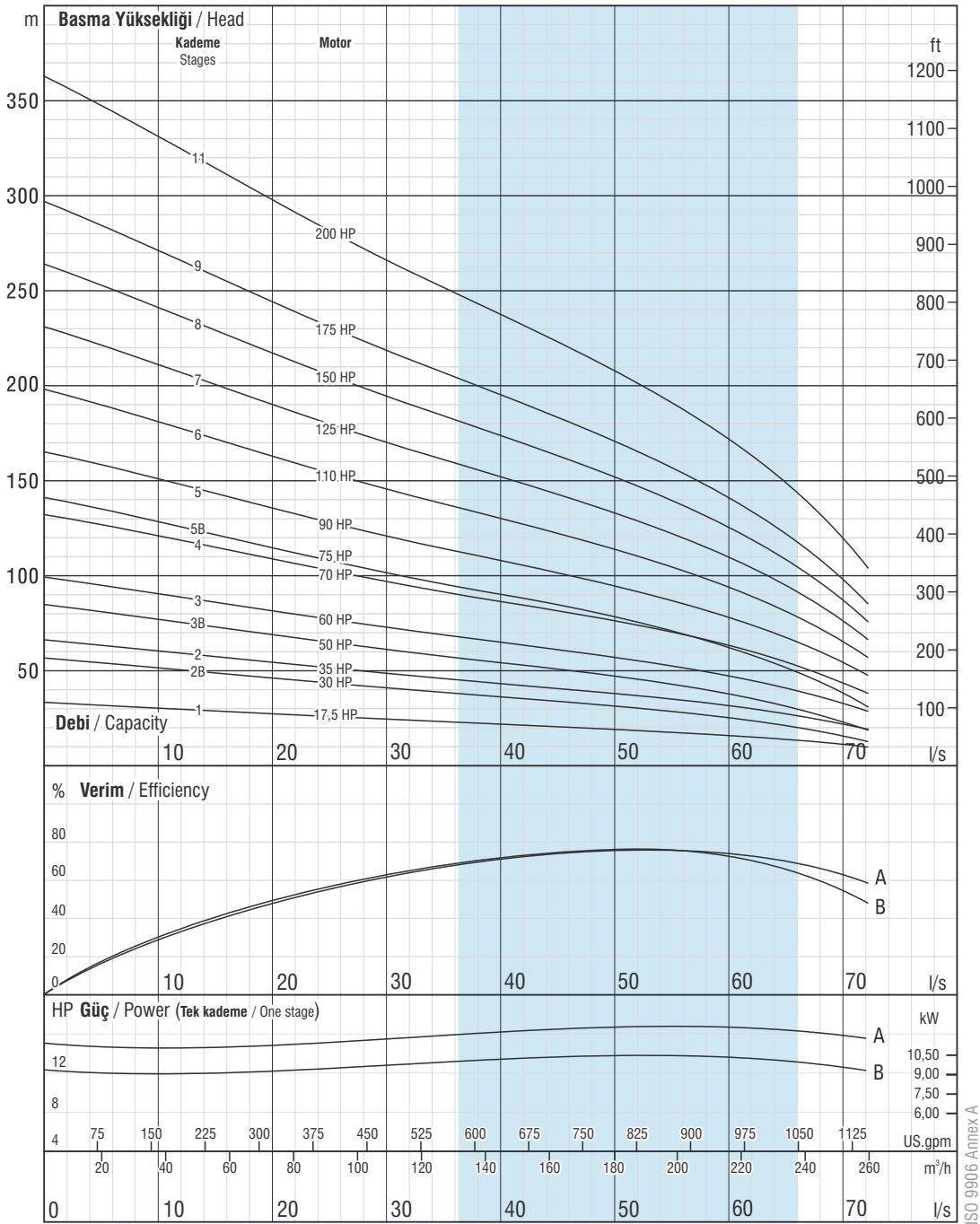

Firmamız teknolojik gelişmeler nedeniyle değişiklik hakkını saklı tutar.

Due to continuous improvement in design we reserve the right to amend specifications or data without prior notice.

VSP 0853

Çark kanat sayısı / No. of vanes
5

Çıkış haznesi bağlantısı / Outlet connection diameter
5" - 6" (içten ve dıştan pasolu)
5" - 6" (inside and outside threaded)

Pompa dış çapı / Pump outside diameter
205 mm

Dönüş Yönü / Rotation
Saatin tersi yönünde / CCW

Devir / Revolution
2900 rpm

Mil çapı / Shaft diameter
30,16 mm



Pompa performans eğrileri 1 bar atmosfer basıncı altında 15 °C sıcaklığındaki, özgül yoğunluğu 1 gr/cm³ olan su ile elde edilmiştir.
The hydraulic working characteristics have been taken with water at 15 °C, at the atmospheric pressure of 1 bar and specific gravity is 1 gr/cm³

Teknik Özellikler

Technical specifications

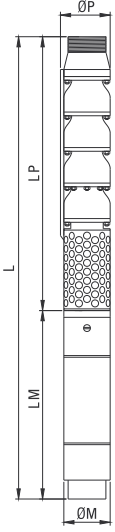

Maks. gerilim değişimi / Voltage
380-415V (+%6-%10)

Frekans / Frequency
50 Hz. / 50 Hz.

Maks. kum miktarı / Max. sand content
50 gr/m³ / 50 gr/m³

Maks. su sıcaklığı / Max. water temp.
30°C (50°C ops.) / 30°C (50°C ops.)

Opsiyonel malzemeler için lütfen irtibata geçiniz.
Please contact us for optional materials.

Ara Çanak / Diffuser

Pik Döküm (GG 20) / Cast Iron (GG 20)
Sfero Döküm (GGG40) / Ductile Iron (GGG40)
Bronz (ASTM B145-4A) / Bronze (ASTM B145-4A)
Paslanmaz Çelik (AISI304, AISI316, duplex) / Stain. Steel (AISI304, AISI316, duplex)

Çark / Impeller

Pik Döküm (GG 20) / Cast Iron (GG 20)
Sfero Döküm (GGG40) / Ductile Iron (GGG40)
Bronz (ASTM B145-4A) / Bronze (ASTM B145-4A)
Paslanmaz Çelik (AISI304, AISI316, duplex) / Stain. Steel (AISI304, AISI316, duplex)

Pompa Mili / Shaft

Paslanmaz Çelik (ASTM A582 type 416-420) / Stain. Steel (ASTM A582 type 416-420)
Paslanmaz Çelik (AISI304, AISI316, duplex) / Stain. Steel (AISI304, AISI316, duplex)

Kaplin / Coupling

Paslanmaz Çelik (ASTM A582 type 416-420) / Stain. Steel (ASTM A582 type 416-420)
Paslanmaz Çelik (AISI304, AISI316, duplex) / Stain. Steel (AISI304, AISI316, duplex)

Çark Tespit Burcu / Collet

Paslanmaz Çelik (ASTM A582 type 416-420) / Stain. Steel (ASTM A582 type 416-420)
Paslanmaz Çelik (AISI304, AISI316, duplex) / Stain. Steel (AISI304, AISI316, duplex)

Süzgeç / Filter

Paslanmaz Çelik (ASTM A582 type 420) / Stain. Steel (ASTM A582 type 420)
Paslanmaz Çelik (AISI304, AISI316) / Stain. Steel (AISI304, AISI316)



TS 11146

Pompa Tipi Pump type	Kad. Sayısı Stages	Motor		Ölçüler / Dimensions (mm)					Ağırlık / Weight (kg)		
		KW	HP	L	LM	LP	ØM	ØP	Motor Motor	Pompa Pump	Toplam Total
VSP 0854/01B	1	15	20	1687	973	714	142	205	72	36	108
VSP 0854/01	1	18,5	25	1720	1006	714	142	205	76	36	112
VSP 0854/02B	2	30	40	1961	1056	905	192	205	129	58	187
VSP 0854/02	2	37	50	2021	1116	905	192	205	138	58	196
VSP 0854/03B	3	45	60	2296	1201	1095	192	205	152	80	232
VSP 0854/03	3	52	70	2381	1286	1095	192	205	170	80	250
VSP 0854/04B	4	60	80	2627	1341	1286	192	205	185	101	286
VSP 0854/04	4	75	100	2677	1391	1286	192	205	195	101	296
VSP 0854/05	5	92	125	2907	1430	1477	231	205	284	123	407
VSP 0854/06	6	110	150	3177	1510	1667	231	205	311	145	456
VSP 0854/07	7	129	175	3468	1610	1858	231	205	338	167	505
VSP 0854/08	8	147	200	3788	1740	2048	231	205	370	189	559

Pompa Tipi Pump type	Kad. Sayısı Stages	Motor		Akım Current (A)	m ³ /h l/s	0	60	120	180	200	220	240	270
		KW	HP			0	16,67	33,33	50,00	55,56	61,11	66,67	75,00
VSP 0854/01B	1	15	20	33,1	Basma Yüksekliği / Head (m)	29	25	20	18	17	17	15	9
VSP 0854/01	1	18,5	25	41,8		33	28	23	20	20	19	18	13
VSP 0854/02B	2	30	40	61,7		58	49	39	36	35	33	29	17
VSP 0854/02	2	37	50	74,3		66	56	45	41	40	39	36	26
VSP 0854/03B	3	45	60	90,4		87	74	59	54	52	50	44	26
VSP 0854/03	3	52	70	103,3		99	85	68	61	60	58	54	39
VSP 0854/04B	4	60	80	119,1		116	98	78	71	70	66	59	34
VSP 0854/04	4	75	100	150,7		132	113	90	82	80	77	71	51
VSP 0854/05	5	92	125	179		165	141	113	102	100	97	89	64
VSP 0854/06	6	110	150	216		199	169	135	123	120	116	107	77
VSP 0854/07	7	129	175	248		232	197	158	143	140	135	125	90
VSP 0854/08	8	147	200	282		265	226	180	163	160	155	143	103

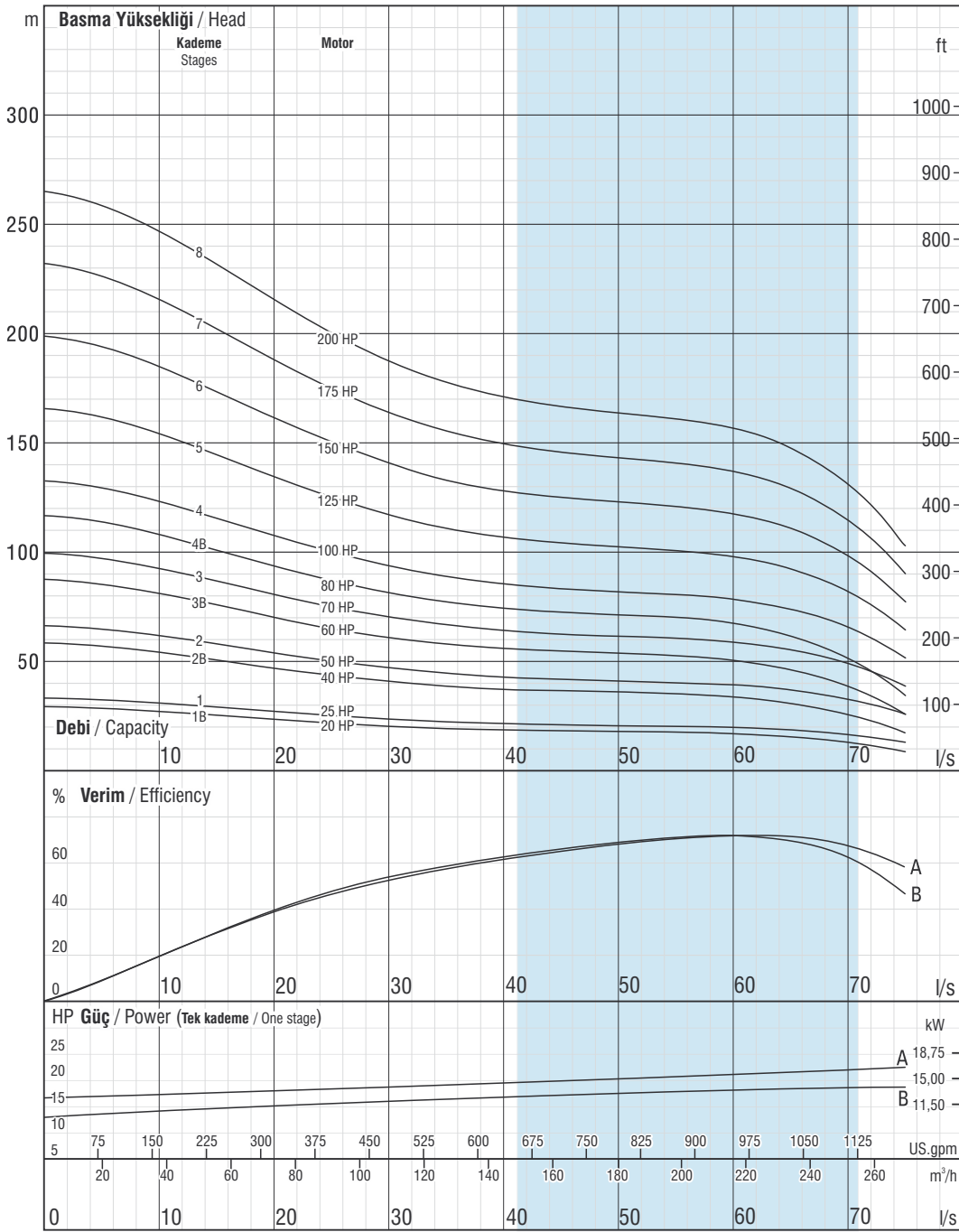

Firmamız teknolojik gelişmeler nedeniyle değişiklik hakkını saklı tutar.

Due to continuous improvement in design we reserve the right to amend specifications or data without prior notice.

VSP 0854

Çark kanat sayısı / No. of vanes
7

Çıkış haznesi bağlantısı / Outlet connection diameter
5" - 6" (içten ve dıştan pasolu)
5" - 6" (inside and outside threaded)

Pompa dış çapı / Pump outside diameter
205 mm

Dönüş Yönü / Rotation
Saatin tersi yönünde / CCW

Devir / Revolution
2900 rpm

Mil çapı / Shaft diameter
30,16 mm



Pompa performans eğrileri 1 bar atmosfer basıncı altında 15 °C sıcaklığındaki, özgül yoğunluğu 1 gr/cm³ olan su ile elde edilmiştir.
The hydraulic working characteristics have been taken with water at 15 °C, at the atmospheric pressure of 1 bar and specific gravity is 1 gr/cm³

Teknik Özellikler

Technical specifications

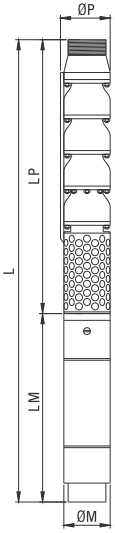

Maks. gerilim değişimi / Voltage
380-415V (+%6-%10)

Frekans / Frequency
50 Hz. / 50 Hz.

Maks. kum miktarı / Max. sand content
50 gr/m³ / 50 gr/m³

Maks. su sıcaklığı / Max. water temp.
30°C (50°C ops.) / 30°C (50°C ops.)

Opsiyonel malzemeler için lütfen irtibata geçiniz.
Please contact us for optional materials.

Ara Çanak / Diffuser

Pik Döküm (GG 20) / Cast Iron (GG 20)
Sfero Döküm (GGG40) / Ductile Iron (GGG40)
Bronz (ASTM B145-4A) / Bronze (ASTM B145-4A)
Paslanmaz Çelik (AISI304, AISI316, duplex) / Stain. Steel (AISI304, AISI316, duplex)

Çark / Impeller

Pik Döküm (GG 20) / Cast Iron (GG 20)
Sfero Döküm (GGG40) / Ductile Iron (GGG40)
Bronz (ASTM B145-4A) / Bronze (ASTM B145-4A)
Paslanmaz (AISI304, AISI316, duplex) / Stain. Steel (AISI304, AISI316, duplex)

Pompa Mili / Shaft

Paslanmaz Çelik (ASTM A582 type 416-420) / Stain. Steel (ASTM A582 type 416-420)
Paslanmaz Çelik (AISI304, AISI316, duplex) / Stain. Steel (AISI304, AISI316, duplex)

Kaplin / Coupling

Paslanmaz Çelik (ASTM A582 type 416-420) / Stain. Steel (ASTM A582 type 416-420)
Paslanmaz Çelik (AISI304, AISI316, duplex) / Stain. Steel (AISI304, AISI316, duplex)

Çark Tespit Burcu / Collet

Paslanmaz Çelik (ASTM A582 type 416-420) / Stain. Steel (ASTM A582 type 416-420)
Paslanmaz Çelik (AISI304, AISI316, duplex) / Stain. Steel (AISI304, AISI316, duplex)

Süzgeç / Filter

Paslanmaz Çelik (ASTM A582 type 420) / Stain. Steel (ASTM A582 type 420)
Paslanmaz Çelik (AISI304, AISI316) / Stain. Steel (AISI304, AISI316)



TS 11146

Pompa Tipi Pump type	Kad. Sayısı Stages	Motor		Ölçüler / Dimensions (mm)					Ağırlık / Weight (kg)		
		KW	HP	L	LM	LP	ØM	ØP	Motor Motor	Pompa Pump	Toplam Total
VSP 0931/03	3	45	60	2271	1201	1070	192	213	152	120	272
VSP 0931/04	4	52	70	2491	1286	1205	192	213	170	150	320
VSP 0931/05B	5	60	80	2681	1341	1340	192	213	185	180	365
VSP 0931/05	5	67	90	2706	1366	1340	192	213	186	180	366
VSP 0931/06B	6	75	100	2866	1391	1475	192	213	195	210	405
VSP 0931/06	6	81	110	2845	1370	1475	231	213	256	210	466
VSP 0931/07	7	92	125	3040	1430	1610	231	213	284	240	524
VSP 0931/08	8	110	150	3255	1510	1745	231	213	311	270	581
VSP 0931/10	10	129	175	3625	1610	2015	231	213	338	330	668
VSP 0931/11	11	147	200	3890	1740	2150	231	213	370	360	730

Pompa Tipi Pump type	Kad. Sayısı Stages	Motor		Akım Current (A)	m ³ /h l/s	0	40	80	120	140	160	180	220
		KW	HP			0	11,11	22,22	33,33	38,89	44,44	50,00	61,11
VSP 0931/03	3	45	60	90,4	Basma Yüksekliği / Head (m)	99	96	89	78	70	61	51	26
VSP 0931/04	4	52	70	103,3		132	127	118	104	93	81	67	34
VSP 0931/05B	5	60	80	119,1		149	143	132	113	100	85	68	26
VSP 0931/05	5	67	90	134,6		165	159	148	129	117	102	84	43
VSP 0931/06B	6	75	100	150,7		178	171	158	136	120	102	81	31
VSP 0931/06	6	81	110	159		198	191	178	155	140	122	101	51
VSP 0931/07	7	92	125	179		231	223	207	181	163	142	118	60
VSP 0931/08	8	110	150	216		264	255	237	207	187	163	135	68
VSP 0931/10	10	129	175	248		330	318	296	259	233	203	169	85
VSP 0931/11	11	147	200	282		363	350	326	285	257	224	186	94

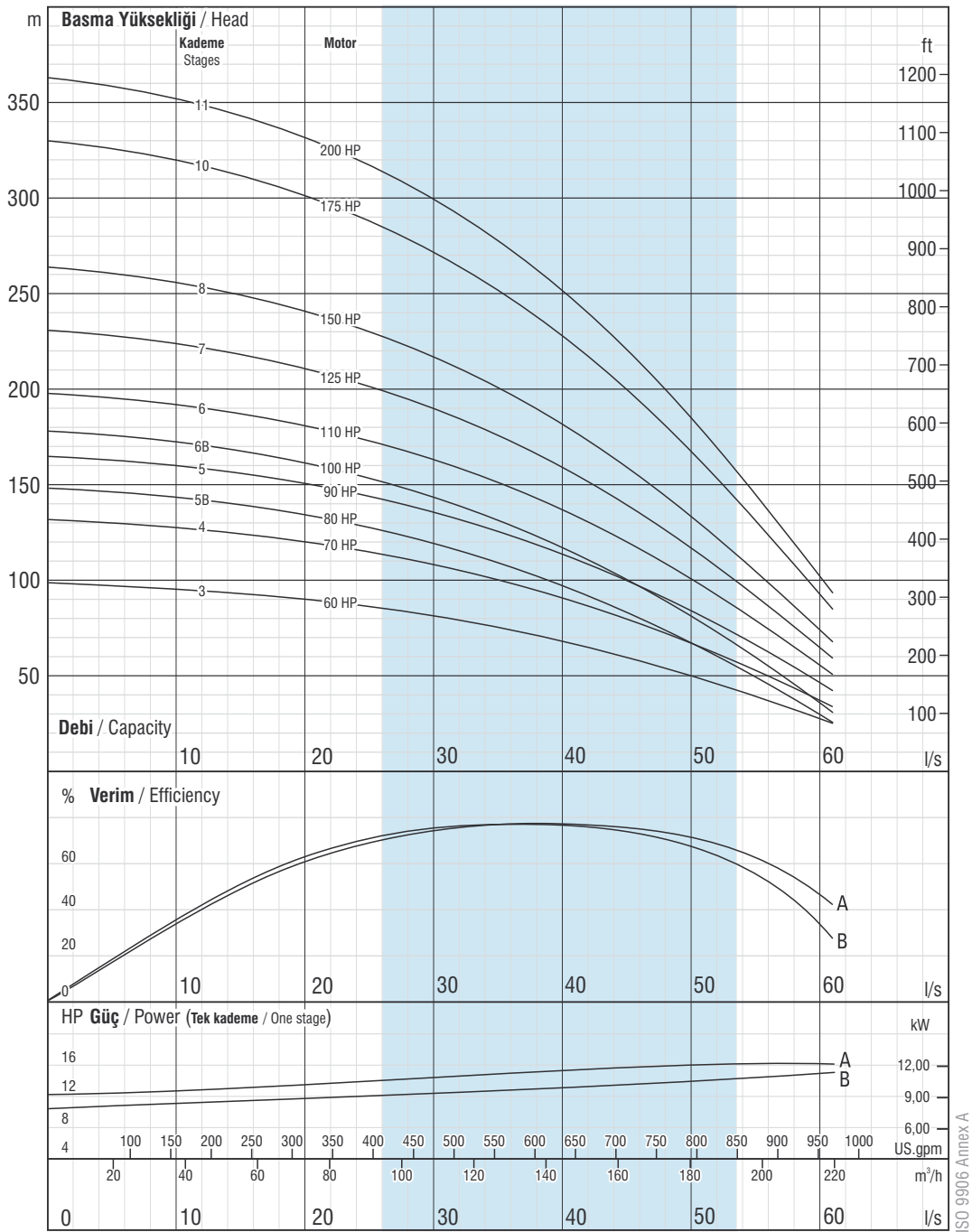

Firmamız teknolojik gelişmeler nedeniyle değişiklik hakkını saklı tutar.

Due to continuous improvement in design we reserve the right to amend specifications or data without prior notice.

VSP 0931

Çark kanat sayısı / No. of vanes
6

Çıkış haznesi bağlantısı / Outlet connection diameter
5" - 6" (içten ve dıştan pasolu)
5" - 6" (inside and outside threaded)

Pompa dış çapı / Pump outside diameter
213 mm

Dönüş Yönü / Rotation
Saatin tersi yönünde / CCW

Devir / Revolution
2900 rpm

Mil çapı / Shaft diameter
30,16 mm



Pompa performans eğrileri 1 bar atmosfer basıncı altında 15 °C sıcaklığındaki, özgül yoğunluğu 1 gr/cm³ olan su ile elde edilmiştir.

The hydraulic working characteristics have been taken with water at 15 °C, at the atmospheric pressure of 1 bar and specific gravity is 1 gr/cm³

Teknik Özellikler

Technical specifications

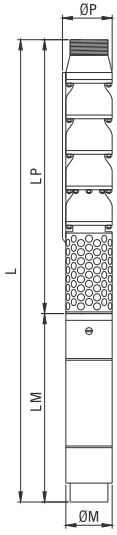

Maks. gerilim değişimi / Voltage
380-415V (+%6-%10)

Frekans / Frequency
50 Hz. / 50 Hz.

Maks. kum miktarı / Max. sand content
50 gr/m³ / 50 gr/m³

Maks. su sıcaklığı / Max. water temp.
30°C (50°C ops.) / 30°C (50°C ops.)

Opsiyonel malzemeler için lütfen irtibata geçiniz.
Please contact us for optional materials.

Ara Çanak / Diffuser

Pik Döküm (GG 20) / Cast Iron (GG 20)
Sfero Döküm (GGG40) / Ductile Iron (GGG40)
Bronz (ASTM B145-4A) / Bronze (ASTM B145-4A)
Paslanmaz Çelik (AISI304, AISI316, duplex) / Stain. Steel (AISI304, AISI316, duplex)

Çark / Impeller

Pik Döküm (GG 20) / Cast Iron (GG 20)
Sfero Döküm (GGG40) / Ductile Iron (GGG40)
Bronz (ASTM B145-4A) / Bronze (ASTM B145-4A)
Paslanmaz (AISI304, AISI316, duplex) / Stain. Steel (AISI304, AISI316, duplex)

Pompa Mili / Shaft

Paslanmaz Çelik (ASTM A582 type 416-420) / Stain. Steel (ASTM A582 type 416-420)
Paslanmaz Çelik (AISI304, AISI316, duplex) / Stain. Steel (AISI304, AISI316, duplex)

Kaplin / Coupling

Paslanmaz Çelik (ASTM A582 type 416-420) / Stain. Steel (ASTM A582 type 416-420)
Paslanmaz Çelik (AISI304, AISI316, duplex) / Stain. Steel (AISI304, AISI316, duplex)

Çark Tespit Burcu / Collet

Paslanmaz Çelik (ASTM A582 type 416-420) / Stain. Steel (ASTM A582 type 416-420)
Paslanmaz Çelik (AISI304, AISI316, duplex) / Stain. Steel (AISI304, AISI316, duplex)

Süzgeç / Filter

Paslanmaz Çelik (ASTM A582 type 420) / Stain. Steel (ASTM A582 type 420)
Paslanmaz Çelik (AISI304, AISI316) / Stain. Steel (AISI304, AISI316)



TS 11146

Pompa Tipi Pump type	Kad. Sayısı Stages	Motor		Ölçüler / Dimensions (mm)					Ağırlık / Weight (kg)		
		KW	HP	L	LM	LP	ØM	ØP	Motor Motor	Pompa Pump	Toplam Total
VSP 0933/03	3	45	60	2271	1201	1070	192	213	152	120	272
VSP 0933/04B	4	52	70	2491	1286	1205	192	213	170	150	320
VSP 0933/04	4	60	80	2546	1341	1205	192	213	185	150	335
VSP 0933/05B	5	67	90	2706	1366	1340	192	213	186	180	366
VSP 0933/05	5	75	100	2731	1391	1340	192	213	195	180	375
VSP 0933/06B	6	81	110	2845	1370	1475	231	213	256	210	466
VSP 0933/06	6	92	125	2905	1430	1475	231	213	284	210	494
VSP 0933/07	7	110	150	3120	1510	1610	231	213	311	240	551
VSP 0933/08	8	129	175	3355	1610	1745	231	213	338	270	608
VSP 0933/09	9	147	200	3620	1740	1880	231	213	370	300	670

Pompa Tipi Pump type	Kad. Sayısı Stages	Motor		Akım Current (A)	m ³ /h l/s	0	70	120	160	180	200	220	260
		KW	HP			0	19,44	33,33	44,44	50,00	55,56	61,11	72,22
VSP 0933/03	3	45	60	90,4	Basma Yüksekliği / Head (m)	99	90	82	73	67	59	51	33
VSP 0933/04B	4	52	70	103,3		119	108	97	84	76	66	56	31
VSP 0933/04	4	60	80	119,1		132	121	110	97	89	79	69	44
VSP 0933/05B	5	67	90	134,6		149	135	122	105	95	83	70	39
VSP 0933/05	5	75	100	150,7		165	151	137	121	111	99	86	55
VSP 0933/06B	6	81	110	159		178	162	146	126	114	100	83	46
VSP 0933/06	6	92	125	179		198	181	165	145	133	119	103	66
VSP 0933/07	7	110	150	216		231	211	192	170	155	139	120	77
VSP 0933/08	8	129	175	248		264	241	220	194	177	159	137	87
VSP 0933/09	9	147	200	282		297	271	247	218	200	178	154	98

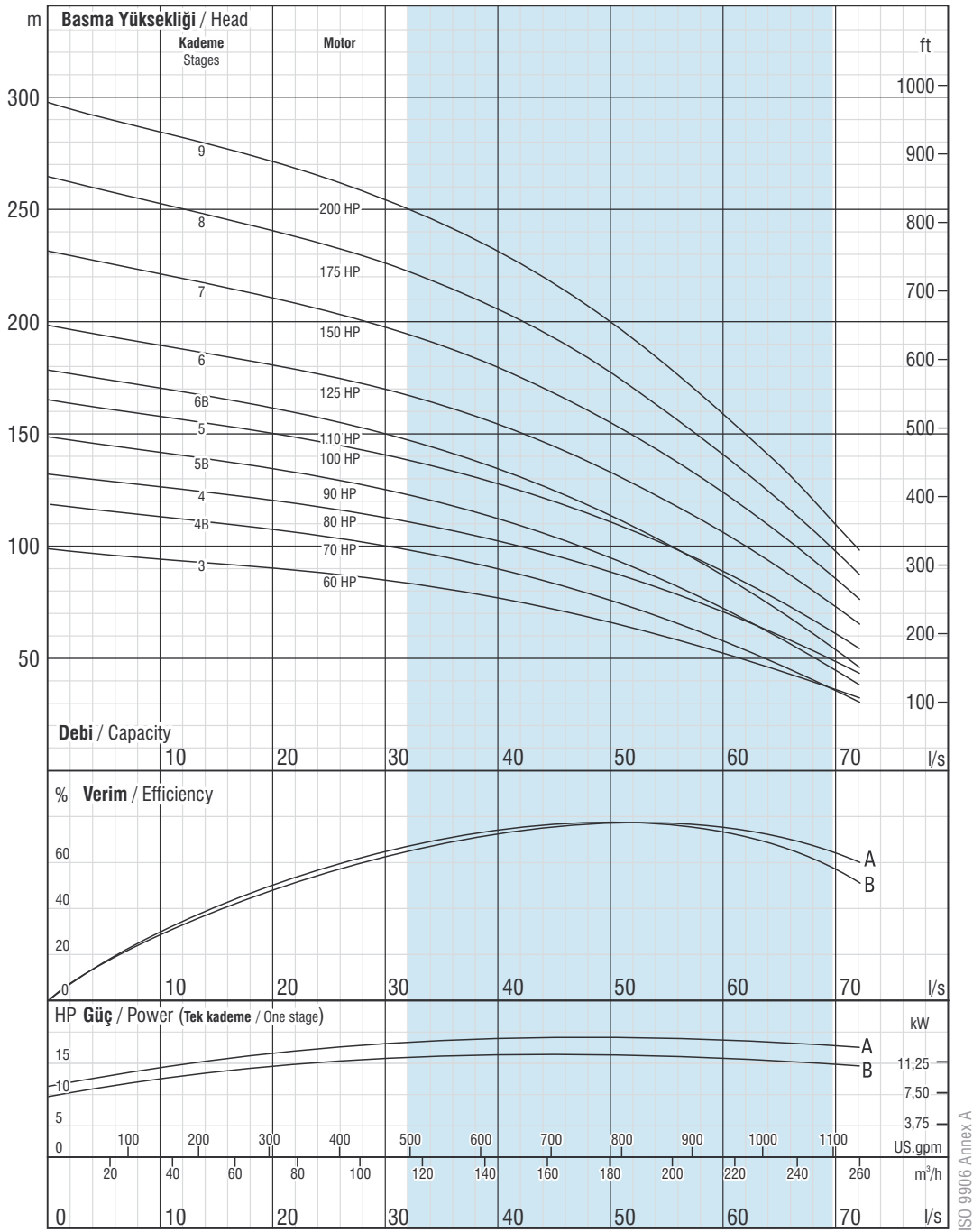

Firmamız teknolojik gelişmeler nedeniyle değişiklik hakkını saklı tutar.

Due to continuous improvement in design we reserve the right to amend specifications or data without prior notice.

VSP 0933

Çark kanat sayısı / No. of vanes
6

Çıkış haznesi bağlantısı / Outlet connection diameter
5" - 6" (içten ve dıştan pasolu)
5" - 6" (inside and outside threaded)

Pompa dış çapı / Pump outside diameter
213 mm

Dönüş Yönü / Rotation
Saatın tersi yönünde / CCW

Devir / Revolution
2900 rpm

Mil çapı / Shaft diameter
30,16 mm



Pompa performans eğrileri 1 bar atmosfer basıncı altında 15 °C sıcaklığındaki, özgül yoğunluğu 1 gr/cm³ olan su ile elde edilmiştir.
The hydraulic working characteristics have been taken with water at 15 °C, at the atmospheric pressure of 1 bar and specific gravity is 1 gr/cm³

Teknik Özellikler

Technical specifications

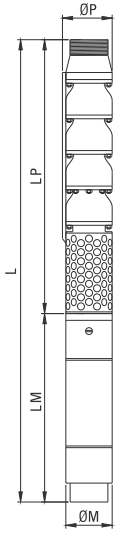

Maks. gerilim değişimi / Voltage
380-415V (+%6-%10)

Frekans / Frequency
50 Hz. / 50 Hz.

Maks. kum miktarı / Max. sand content
50 gr/m³ / 50 gr/m³

Maks. su sıcaklığı / Max. water temp.
30°C (50°C ops.) / 30°C (50°C ops.)

Opsiyonel malzemeler için lütfen irtibata geçiniz.
Please contact us for optional materials.

Ara Çanak / Diffuser

Pik Döküm (GG 20) / Cast Iron (GG 20)
Sfero Döküm (GGG40) / Ductile Iron (GGG40)
Bronz (ASTM B145-4A) / Bronze (ASTM B145-4A)
Paslanmaz Çelik (AISI304, AISI316, duplex) / Stain. Steel (AISI304, AISI316, duplex)

Çark / Impeller

Pik Döküm (GG 20) / Cast Iron (GG 20)
Sfero Döküm (GGG40) / Ductile Iron (GGG40)
Bronz (ASTM B145-4A) / Bronze (ASTM B145-4A)
Paslanmaz (AISI304, AISI316, duplex) / Stain. Steel (AISI304, AISI316, duplex)

Pompa Mili / Shaft

Paslanmaz Çelik (ASTM A582 type 416-420) / Stain. Steel (ASTM A582 type 416-420)
Paslanmaz Çelik (AISI304, AISI316, duplex) / Stain. Steel (AISI304, AISI316, duplex)

Kaplin / Coupling

Paslanmaz Çelik (ASTM A582 type 416-420) / Stain. Steel (ASTM A582 type 416-420)
Paslanmaz Çelik (AISI304, AISI316, duplex) / Stain. Steel (AISI304, AISI316, duplex)

Çark Tespit Burcu / Collet

Paslanmaz Çelik (ASTM A582 type 416-420) / Stain. Steel (ASTM A582 type 416-420)
Paslanmaz Çelik (AISI304, AISI316, duplex) / Stain. Steel (AISI304, AISI316, duplex)

Süzgeç / Filter

Paslanmaz Çelik (ASTM A582 type 420) / Stain. Steel (ASTM A582 type 420)
Paslanmaz Çelik (AISI304, AISI316) / Stain. Steel (AISI304, AISI316)



TS 11146

Pompa Tipi Pump type	Kad. Sayısı Stages	Motor		Ölçüler / Dimensions (mm)					Ağırlık / Weight (kg)		
		KW	HP	L	LM	LP	ØM	ØP	Motor Motor	Pompa Pump	Toplam Total
VSP 1032/01	1	26,5	35	1926	1217	709	142	245	98	70	168
VSP 1032/02B	2	37	50	2038	1116	922	192	245	138	100	238
VSP 1032/02	2	52	70	2208	1286	922	192	245	170	100	270
VSP 1032/03B	3	60	80	2476	1341	1135	192	245	185	130	315
VSP 1032/03	3	81	110	2505	1370	1135	231	245	256	130	386
VSP 1032/04B	4	75	100	2738	1391	1347	192	245	195	160	355
VSP 1032/04	4	110	150	2857	1510	1347	231	245	311	160	471
VSP 1032/05	5	129	175	3170	1610	1560	231	245	338	190	528

Pompa Tipi Pump type	Kad. Sayısı Stages	Motor		Akım Current (A)	m ³ /h l/s	0	120	160	200	220	240	260	290
		KW	HP			0	33,33	44,44	55,56	61,11	66,67	72,22	80,56
VSP 1032/01	1	26,5	35	56,4	Basma Yüksekliği / Head (m)	47	41	38	34	31	29	26	20
VSP 1032/0B2	2	37	50	74,3		74	64	59	51	47	41	35	25
VSP 1032/02	2	52	70	103,3		93	82	76	68	63	57	51	41
VSP 1032/03B	3	60	80	119,1		111	97	88	77	70	62	53	37
VSP 1032/03	3	81	110	159		140	123	114	102	94	86	77	61
VSP 1032/04B	4	75	100	150,7		148	129	118	102	93	83	71	50
VSP 1032/04	4	110	150	216		186	164	151	136	126	115	103	81
VSP 1032/05	5	129	175	248		233	205	189	169	157	144	128	102

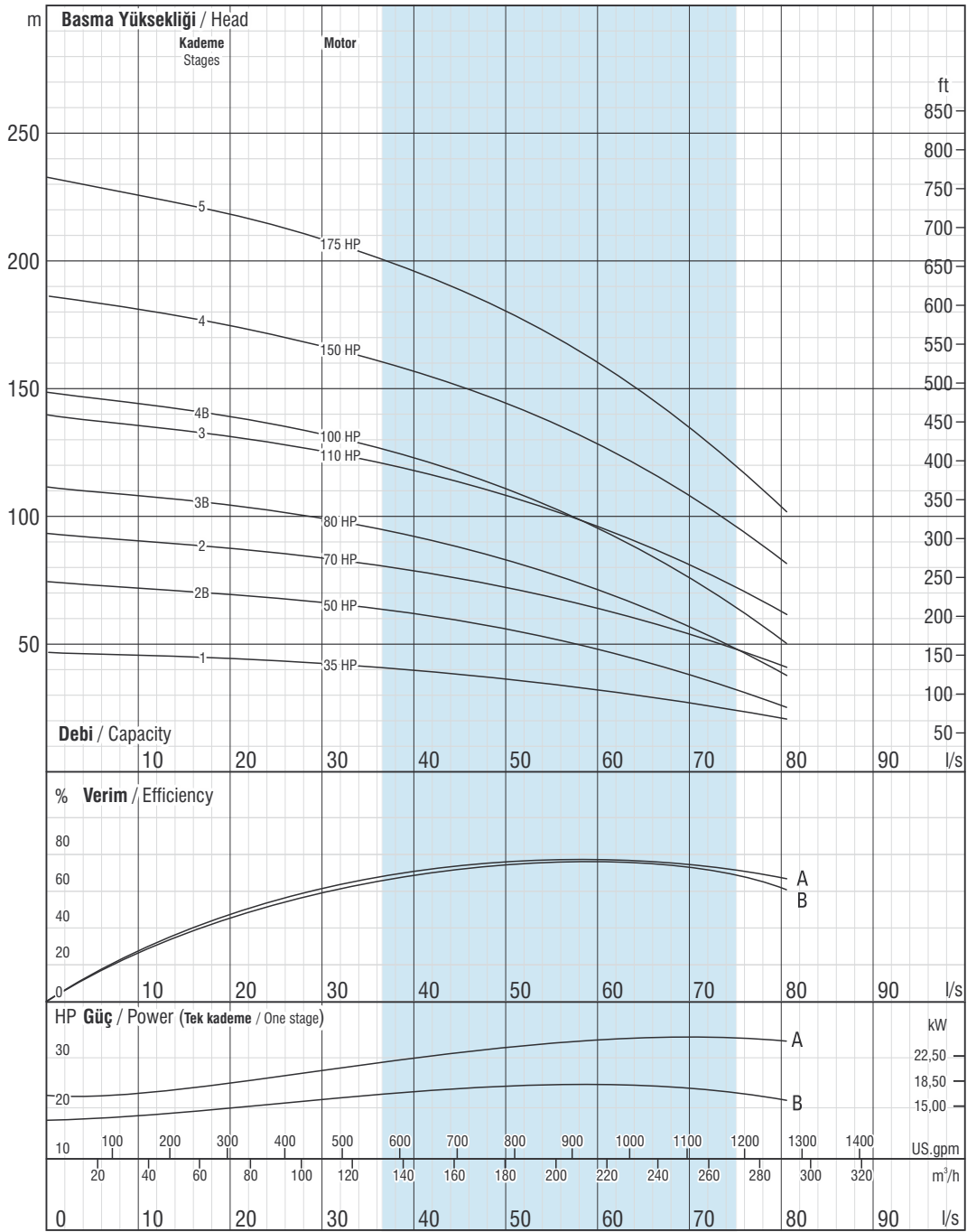

Firmamız teknolojik gelişmeler nedeniyle değişiklik hakkını saklı tutar.

Due to continuous improvement in design we reserve the right to amend specifications or data without prior notice.

VSP 1032

Çark kanat sayısı / No. of vanes
5

Çıkış haznesi bağlantısı / Outlet connection diameter
6" - 8" (içten ve dıştan pasolu)
6" - 8" (inside and outside threaded)

Pompa dış çapı / Pump outside diameter
245 mm

Dönüş Yönü / Rotation
Saatin tersi yönünde / CCW

Devir / Revolution
2900 rpm

Mil çapı / Shaft diameter
42,86 mm

Pompa performans eğrileri 1 bar atmosfer basıncı altında 15 °C sıcaklığındaki, özgül yoğunluğu 1 gr/cm³ olan su ile elde edilmiştir.

The hydraulic working characteristics have been taken with water at 15 °C, at the atmospheric pressure of 1 bar and specific gravity is 1 gr/cm³



Teknik Özellikler

Technical specifications

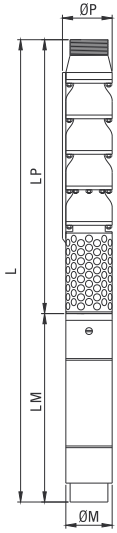

Maks. gerilim değişimi / Voltage
380-415V (+%6-%10)

Frekans / Frequency
50 Hz. / 50 Hz.

Maks. kum miktarı / Max. sand content
50 gr/m³ / 50 gr/m³

Maks. su sıcaklığı / Max. water temp.
30°C (50°C ops.) / 30°C (50°C ops.)

Opsiyonel malzemeler için lütfen irtibata geçiniz.
Please contact us for optional materials.

Ara Çanak / Diffuser

Pik Döküm (GG 20) / Cast Iron (GG 20)
Sfero Döküm (GGG40) / Ductile Iron (GGG40)
Bronz (ASTM B145-4A) / Bronze (ASTM B145-4A)
Paslanmaz Çelik (AISI304, AISI316, duplex) / Stain. Steel (AISI304, AISI316, duplex)

Çark / Impeller

Pik Döküm (GG 20) / Cast Iron (GG 20)
Sfero Döküm (GGG40) / Ductile Iron (GGG40)
Bronz (ASTM B145-4A) / Bronze (ASTM B145-4A)
Paslanmaz (AISI304, AISI316, duplex) / Stain. Steel (AISI304, AISI316, duplex)

Pompa Mili / Shaft

Paslanmaz Çelik (ASTM A582 type 416-420) / Stain. Steel (ASTM A582 type 416-420)
Paslanmaz Çelik (AISI304, AISI316, duplex) / Stain. Steel (AISI304, AISI316, duplex)

Kaplin / Coupling

Paslanmaz Çelik (ASTM A582 type 416-420) / Stain. Steel (ASTM A582 type 416-420)
Paslanmaz Çelik (AISI304, AISI316, duplex) / Stain. Steel (AISI304, AISI316, duplex)

Çark Tespit Burcu / Collet

Paslanmaz Çelik (ASTM A582 type 416-420) / Stain. Steel (ASTM A582 type 416-420)
Paslanmaz Çelik (AISI304, AISI316, duplex) / Stain. Steel (AISI304, AISI316, duplex)

Süzgeç / Filter

Paslanmaz Çelik (ASTM A582 type 420) / Stain. Steel (ASTM A582 type 420)
Paslanmaz Çelik (AISI304, AISI316) / Stain. Steel (AISI304, AISI316)



TS 11146

Pompa Tipi Pump type	Kad. Sayısı Stages	Motor		Ölçüler / Dimensions (mm)					Ağırlık / Weight (kg)		
		KW	HP	L	LM	LP	ØM	ØP	Motor Motor	Pompa Pump	Toplam Total
VSP 1033/01B	1	26,5	35	1926	1217	709	142	245	98	70	168
VSP 1033/01	1	30	40	1765	1056	709	192	245	129	70	199
VSP 1033/02B	2	52	70	2208	1286	922	192	245	170	100	270
VSP 1033/02	2	60	80	2263	1341	922	192	245	185	100	285
VSP 1033/03B	3	75	100	2526	1391	1135	192	245	195	130	325
VSP 1033/03	3	92	125	2565	1430	1135	231	245	284	130	414
VSP 1033/04B	4	110	150	2857	1510	1347	231	245	311	160	471
VSP 1033/04A	4	129	175	2957	1610	1347	231	245	338	160	498
VSP 1033/06B	6	147	200	3513	1740	1773	231	245	370	220	590

Pompa Tipi Pump type	Kad. Sayısı Stages	Motor		Akım Current (A)	m ³ /h l/s	0	130	200	240	260	280	300	330
		KW	HP			0	36,11	55,56	66,67	72,22	77,78	83,33	91,67
VSP 1033/01B	1	26,5	35	56,4	Basma Yüksekliği / Head (m)	42	38	32	29	26	24	21	14
VSP 1033/01	1	30	40	61,7		46	41	36	33	31	28	25	20
VSP 1033/02B	2	52	70	103,3		84	75	65	57	53	48	41	28
VSP 1033/02	2	60	80	119,1		92	81	72	66	61	56	50	40
VSP 1033/03B	3	75	100	150,7		126	113	97	86	79	71	62	43
VSP 1033/03	3	92	125	179		138	122	108	98	92	84	74	59
VSP 1033/04B	4	110	150	216		168	151	129	115	106	95	82	57
VSP 1033/04A	4	129	175	248		184	162	144	131	122	112	99	79
VSP 1033/06B	6	147	200	282		252	226	194	172	159	143	123	85

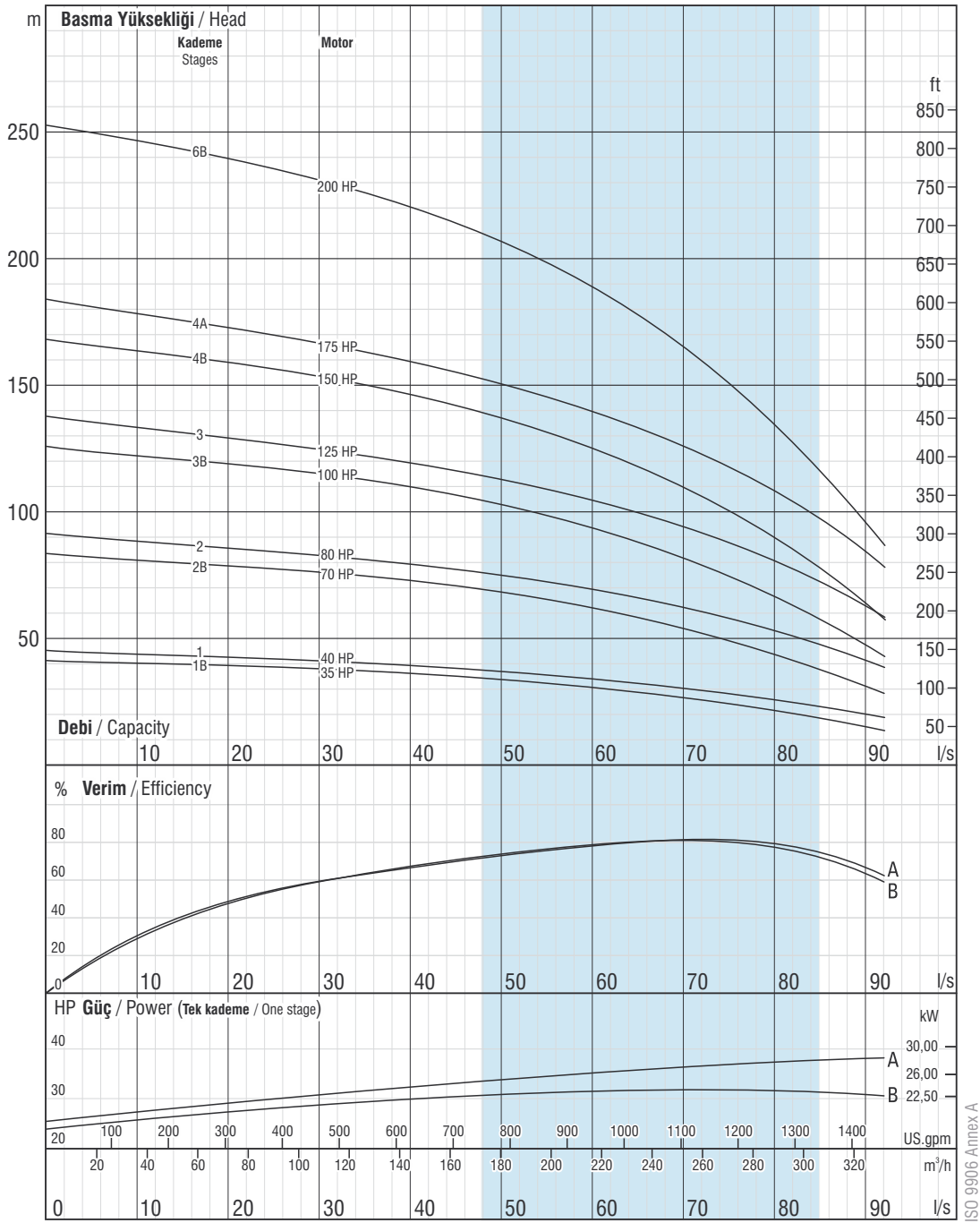

Firmamız teknolojik gelişmeler nedeniyle değişiklik hakkını saklı tutar.

Due to continuous improvement in design we reserve the right to amend specifications or data without prior notice.

VSP 1033

Çark kanat sayısı / No. of vanes
5

Çıkış haznesi bağlantısı / Outlet connection diameter
6" - 8" (içten ve dıştan pasolu)
6" - 8" (inside and outside threaded)

Pompa dış çapı / Pump outside diameter
245 mm

Dönüş Yönü / Rotation
Saatın tersi yönünde / CCW

Devir / Revolution
2900 rpm

Mil çapı / Shaft diameter
42,86 mm



Pompa performans eğrileri 1 bar atmosfer basıncı altında 15 °C sıcaklığındaki, özgül yoğunluğu 1 gr/cm³ olan su ile elde edilmiştir.
The hydraulic working characteristics have been taken with water at 15 °C, at the atmospheric pressure of 1 bar and specific gravity is 1 gr/cm³

Teknik Özellikler

Technical specifications

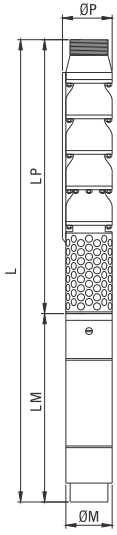

Maks. gerilim değişimi / Voltage
380-415V (+%6-%10)

Frekans / Frequency
50 Hz. / 50 Hz.

Maks. kum miktarı / Max. sand content
50 gr/m³ / 50 gr/m³

Maks. su sıcaklığı / Max. water temp.
30°C (50°C ops.) / 30°C (50°C ops.)

Opsiyonel malzemeler için lütfen irtibata geçiniz.
Please contact us for optional materials.

Ara Çanak / Diffuser

Pik Döküm (GG 20) / Cast Iron (GG 20)
Sfero Döküm (GGG40) / Ductile Iron (GGG40)
Bronz (ASTM B145-4A) / Bronze (ASTM B145-4A)
Paslanmaz Çelik (AISI304, AISI316, duplex) / Stain. Steel (AISI304, AISI316, duplex)

Çark / Impeller

Pik Döküm (GG 20) / Cast Iron (GG 20)
Sfero Döküm (GGG40) / Ductile Iron (GGG40)
Bronz (ASTM B145-4A) / Bronze (ASTM B145-4A)
Paslanmaz (AISI304, AISI316, duplex) / Stain. Steel (AISI304, AISI316, duplex)

Pompa Mili / Shaft

Paslanmaz Çelik (ASTM A582 type 416-420) / Stain. Steel (ASTM A582 type 416-420)
Paslanmaz Çelik (AISI304, AISI316, duplex) / Stain. Steel (AISI304, AISI316, duplex)

Kaplin / Coupling

Paslanmaz Çelik (ASTM A582 type 416-420) / Stain. Steel (ASTM A582 type 416-420)
Paslanmaz Çelik (AISI304, AISI316, duplex) / Stain. Steel (AISI304, AISI316, duplex)

Çark Tespit Burcu / Collet

Paslanmaz Çelik (ASTM A582 type 416-420) / Stain. Steel (ASTM A582 type 416-420)
Paslanmaz Çelik (AISI304, AISI316, duplex) / Stain. Steel (AISI304, AISI316, duplex)

Süzgeç / Filter

Paslanmaz Çelik (ASTM A582 type 420) / Stain. Steel (ASTM A582 type 420)
Paslanmaz Çelik (AISI304, AISI316) / Stain. Steel (AISI304, AISI316)



TS 11146

Pompa Tipi Pump type	Kad. Sayısı Stages	Motor		Ölçüler / Dimensions (mm)					Ağırlık / Weight (kg)		
		KW	HP	L	LM	LP	ØM	ØP	Motor Motor	Pompa Pump	Toplam Total
VSP 1034/01B	1	37	50	1825	1116	709	192	245	138	70	208
VSP 1034/01	1	45	60	1910	1201	709	192	245	152	70	222
VSP 1034/02B	2	67	90	2288	1366	922	192	245	186	100	286
VSP 1034/02	2	92	125	2352	1430	922	231	245	284	100	384
VSP 1034/03B	3	110	150	2645	1510	1135	231	245	311	130	441
VSP 1034/03	3	129	175	2745	1610	1135	231	245	338	130	468
VSP 1034/04B	4	147	200	3087	1740	1347	231	245	370	160	530
VSP 1034/04	4	166	225	3167	1820	1347	231	245	400	160	560
VSP 1034/05B	5	185	250	3380	1820	1560	231	245	405	190	595

Pompa Tipi Pump type	Kad. Sayısı Stages	Motor		Akım Current (A)	m ³ /h l/s	0	180	210	260	290	320	350	390	
		KW	HP			0	50,00	58,33	72,22	80,56	88,89	97,22	108,33	
VSP 1034/01B	1	37	50	74,3	Basma Yüksekliği / Head (m)	44	37	35	32	30	27	23	14	
VSP 1034/01	1	45	60	90,4		50	43	42	39	37	34	30	23	23
VSP 1034/02B	2	67	90	134,6		87	73	71	65	60	54	46	28	28
VSP 1034/02	2	92	125	179		101	86	83	77	73	68	61	47	47
VSP 1034/03B	3	110	150	216		131	110	106	97	90	81	68	42	42
VSP 1034/03	3	129	175	248		151	129	125	116	110	102	91	70	70
VSP 1034/04B	4	147	200	282		175	147	141	130	121	108	91	56	56
VSP 1034/04	4	166	225	322		202	172	166	155	146	136	122	94	94
VSP 1034/05B	5	185	250	359		218	184	177	162	151	135	114	70	70

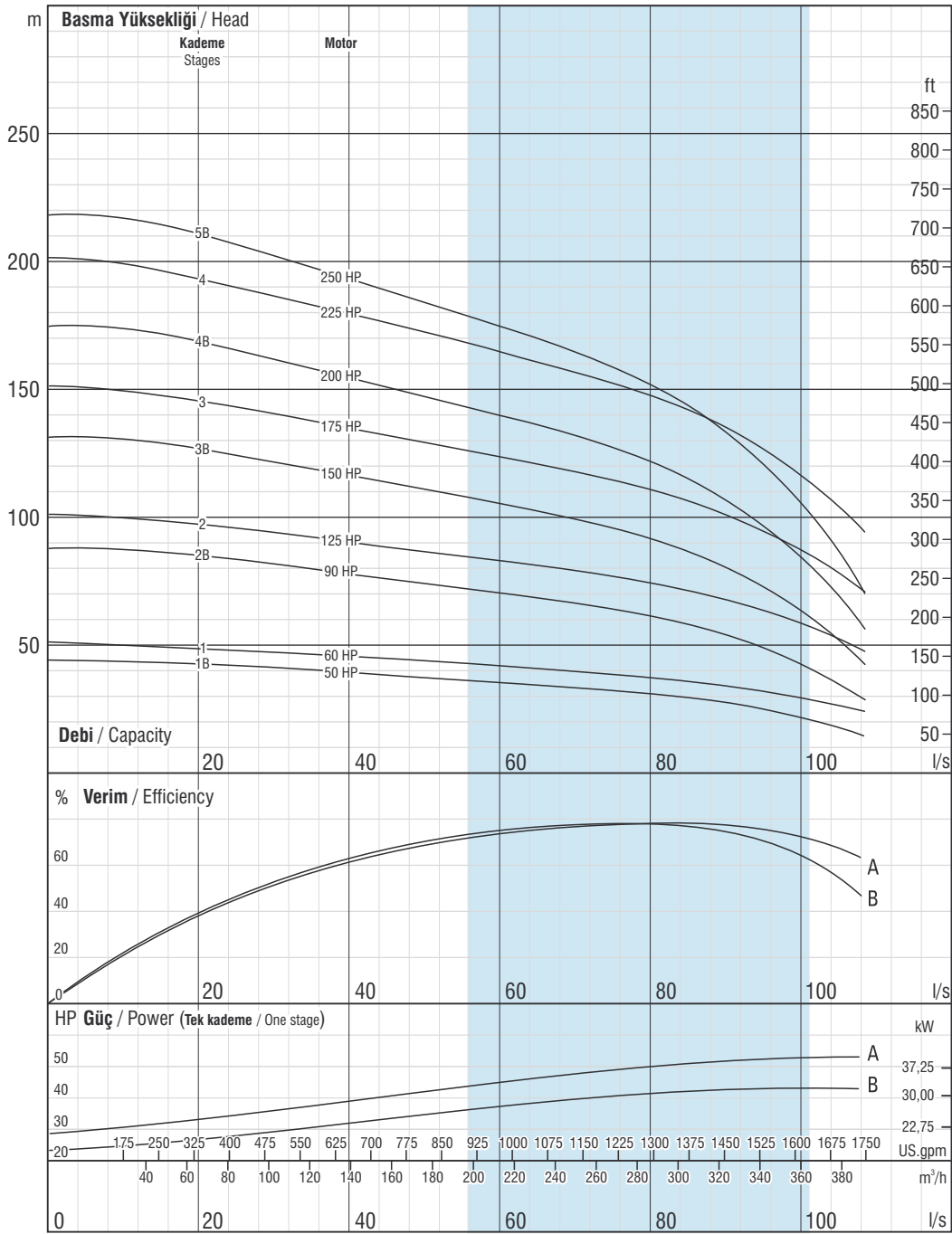

Firmamız teknolojik gelişmeler nedeniyle değişiklik hakkını saklı tutar.

Due to continuous improvement in design we reserve the right to amend specifications or data without prior notice.

VSP 1034

Çark kanat sayısı / No. of vanes
7

Çıkış haznesi bağlantısı / Outlet connection diameter
6" - 8" (içten ve dıştan pasolu)
6" - 8" (inside and outside threaded)

Pompa dış çapı / Pump outside diameter
245 mm

Dönüş Yönü / Rotation
Saatın tersi yönünde / CCW

Devir / Revolution
2900 rpm

Mil çapı / Shaft diameter
42,86 mm



Pompa performans eğrileri 1 bar atmosfer basıncı altında 15 °C sıcaklığındaki, özgül yoğunluğu 1 gr/cm³ olan su ile elde edilmiştir.

The hydraulic working characteristics have been taken with water at 15 °C, at the atmospheric pressure of 1 bar and specific gravity is 1 gr/cm³

Teknik Özellikler

Technical specifications

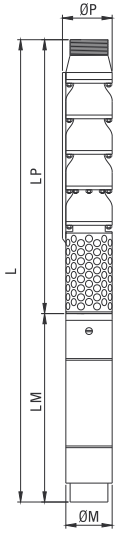

Maks. gerilim değişimi / Voltage
380-415V (+%6-%10)

Frekans / Frequency
50 Hz. / 50 Hz.

Maks. kum miktarı / Max. sand content
50 gr/m³ / 50 gr/m³

Maks. su sıcaklığı / Max. water temp.
30°C (50°C ops.) / 30°C (50°C ops.)

Opsiyonel malzemeler için lütfen irtibata geçiniz.
Please contact us for optional materials.

Ara Çanak / Diffuser

Pik Döküm (GG 20) / Cast Iron (GG 20)
Sfero Döküm (GGG40) / Ductile Iron (GGG40)
Bronz (ASTM B145-4A) / Bronze (ASTM B145-4A)
Paslanmaz Çelik (AISI304, AISI316, duplex) / Stain. Steel (AISI304, AISI316, duplex)

Çark / Impeller

Pik Döküm (GG 20) / Cast Iron (GG 20)
Sfero Döküm (GGG40) / Ductile Iron (GGG40)
Bronz (ASTM B145-4A) / Bronze (ASTM B145-4A)
Paslanmaz (AISI304, AISI316, duplex) / Stain. Steel (AISI304, AISI316, duplex)

Pompa Mili / Shaft

Paslanmaz Çelik (ASTM A582 type 416-420) / Stain. Steel (ASTM A582 type 416-420)
Paslanmaz Çelik (AISI304, AISI316, duplex) / Stain. Steel (AISI304, AISI316, duplex)

Kaplin / Coupling

Paslanmaz Çelik (ASTM A582 type 416-420) / Stain. Steel (ASTM A582 type 416-420)
Paslanmaz Çelik (AISI304, AISI316, duplex) / Stain. Steel (AISI304, AISI316, duplex)

Çark Tespit Burcu / Collet

Paslanmaz Çelik (ASTM A582 type 416-420) / Stain. Steel (ASTM A582 type 416-420)
Paslanmaz Çelik (AISI304, AISI316, duplex) / Stain. Steel (AISI304, AISI316, duplex)

Süzgeç / Filter

Paslanmaz Çelik (ASTM A582 type 420) / Stain. Steel (ASTM A582 type 420)
Paslanmaz Çelik (AISI304, AISI316) / Stain. Steel (AISI304, AISI316)



TS 11146

Pompa Tipi Pump type	Kad. Sayısı Stages	Motor		Ölçüler / Dimensions (mm)					Ağırlık / Weight (kg)		
		KW	HP	L	LM	LP	ØM	ØP	Motor Motor	Pompa Pump	Toplam Total
VSP 1232/01	1	52	70	2146	1286	860	192	286	170	110	280
VSP 1232/02B	2	92	125	2545	1430	1115	231	286	284	152	436
VSP 1232/02	2	110	150	2625	1510	1115	231	286	311	152	463
VSP 1232/03B	3	147	200	3110	1740	1370	231	286	370	194	564
VSP 1232/03	3	166	225	3190	1820	1370	231	286	400	194	594
VSP 1232/04B	4	185	250	3445	1820	1625	231	286	405	236	641

Pompa Tipi Pump type	Kad. Sayısı Stages	Motor		Akım Current (A)	m ³ /h l/s	0	180	260	320	380	420	460	500
		KW	HP			0	50,00	72,22	88,89	105,56	116,67	127,78	138,89
VSP 1232/01	1	52	70	103,3	Basma Yüksekliği / Head (m)	64	51	47	43	38	33	28	23
VSP 1232/02B	2	92	125	179		115	92	83	76	66	57	47	36
VSP 1232/02	2	110	150	216		127	103	93	85	75	67	56	45
VSP 1232/03B	3	147	200	282		173	139	125	114	99	86	71	55
VSP 1232/03	3	166	225	322		191	154	140	128	113	100	84	68
VSP 1232/04B	4	185	250	359		230	185	167	152	132	114	94	73

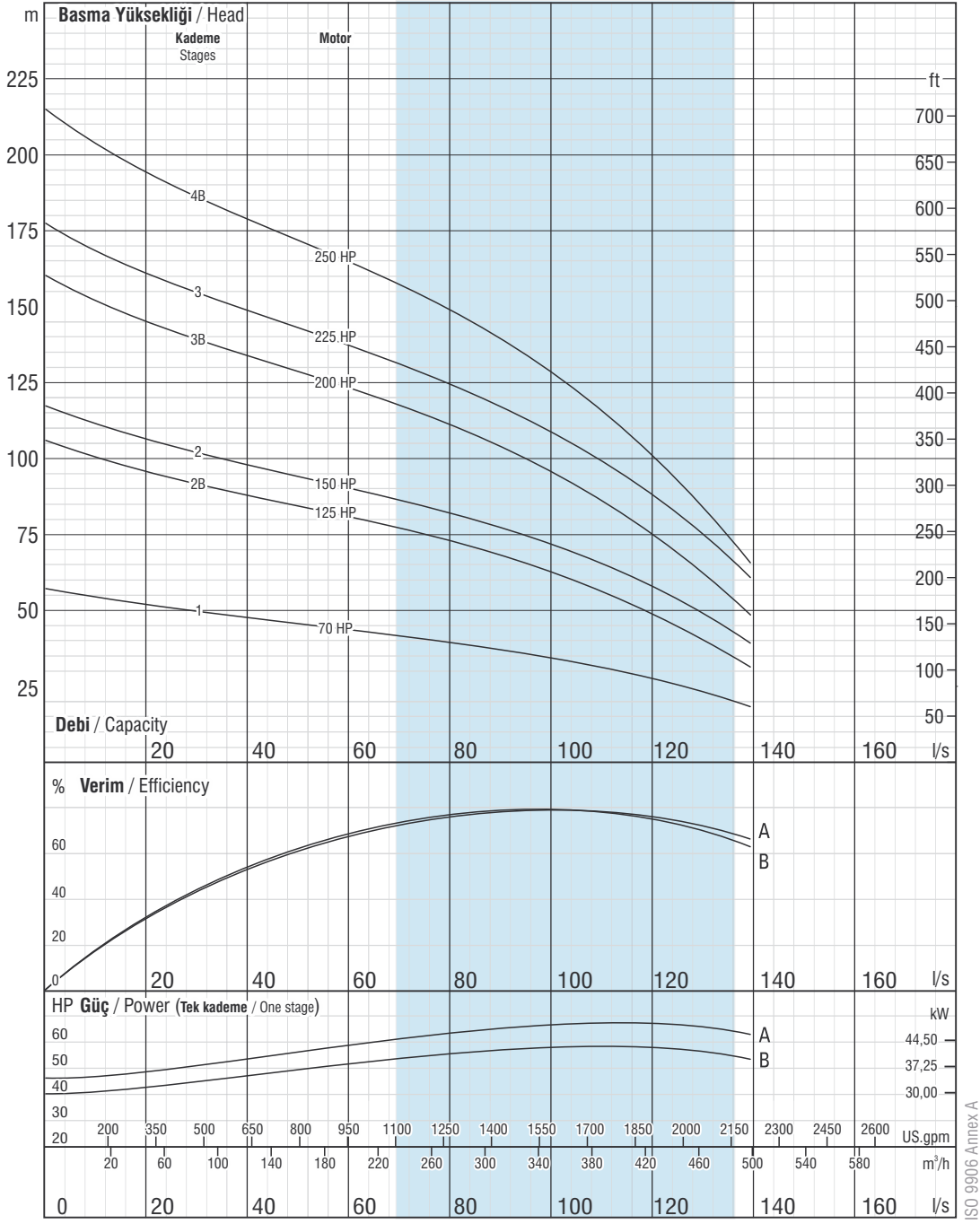

Firmamız teknolojik gelişmeler nedeniyle değişiklik hakkını saklı tutar.
Due to continuous improvement in design we reserve the right to amend specifications or data without prior notice.

ISO 9906 Annex A

VSP 1232

Çark kanat sayısı / No. of vanes
8

Çıkış haznesi bağlantısı / Outlet connection diameter
10" - 12" (içten ve dıştan pasolu)
10" - 12" (inside and outside threaded)

Pompa dış çapı / Pump outside diameter
286 mm

Dönüş Yönü / Rotation
Saatin tersi yönünde / CCW

Devir / Revolution
2900 rpm

Mil çapı / Shaft diameter
49,21 mm



Pompa performans eğrileri 1 bar atmosfer basıncı altında 15 °C sıcaklığındaki, özgül yoğunluğu 1 gr/cm³ olan su ile elde edilmiştir.
The hydraulic working characteristics have been taken with water at 15 °C, at the atmospheric pressure of 1 bar and specific gravity is 1 gr/cm³

Direkt (DOL)

HP	Kablo Ölçüleri / Cable Sizes										
	3x1,5	3x2,5	3x4	3x6	3x10	3x16	3x25	3x35	3x50	3x70	3x95
5,5	65	108	172	258	431	689	1.077	1.507	2.153	3.014	4.091
7,5	48	80	129	193	322	515	805	1.127	1.610	2.254	3.059
10	38	64	102	153	256	409	639	894	1.278	1.789	2.428
12,5		52	83	125	209	334	522	730	1.043	1.461	1.982
15		45	72	109	181	289	452	633	904	1.266	1.718
17,5			61	92	153	245	383	536	765	1.071	1.454
20			52	79	131	210	327	458	655	917	1.244
25					106	170	266	372	531	744	1.009
30					90	145	226	316	452	633	859
35					76	122	190	266	380	532	722
40					67	107	168	235	336	470	638
50						89	139	195	279	390	529
60							115	160	229	321	434
70								139	198	278	377
75								131	187	262	356
80								120	172	241	326
90									154	215	292
100									132	192	261
110									127	178	242
125										157	213
150											182
175											155
200											
210											

Yıldız - Üçgen (Wye - Delta)

HP	Kablo Ölçüleri / Cable Sizes										
	3x1,5	3x2,5	3x4	3x6	3x10	3x16	3x25	3x35	3x50	3x70	3x95
5,5	97	161	258	388	646	1.033	1.615	2.261	3.230	4.521	6.136
7,5	72	121	193	290	483	773	1.207	1.690	2.415	3.381	4.588
10	57	96	153	230	383	613	958	1.342	1.916	2.683	3.641
12,5	47	78	125	188	313	501	783	1.096	1.565	2.191	2.974
15	41	68	109	163	271	434	678	949	1.356	1.899	2.577
17,5	34	57	92	138	230	367	574	803	1.148	1.607	2.181
20	29	49	79	118	196	314	491	688	982	1.375	1.867
25		40	64	96	159	255	398	558	797	1.115	1.514
30			54	81	136	217	339	475	678	949	1.288
35			46	68	114	182	285	399	570	798	1.083
40				60	101	161	252	352	503	705	956
50					84	134	209	293	418	585	794
60					69	110	172	241	344	481	653
70					59	95	149	208	297	416	565
75						90	141	197	281	394	534
80						82	129	180	258	361	490
90						74	115	162	231	323	439
100							103	144	206	289	392
110							95	134	191	267	363
125								118	168	235	319
150								101	144	201	273
175									123	172	233
200										152	207
210										145	196



10035 Sk. No:10 A.O.S.B. 35620 - Cigli, Izmir / TURKEY
T: +90 (232) 376 76 50 • F: +90 (232) 328 01 68
www.vansan.com.tr • vansan@vansan.com.tr

